

# GROWRILLA®

HYDROPONICS



new **2.0 PRO**

## MANUAL INSTRUCTION



+39 329 3237168



Strada Comunale da Bertolla  
all'Abbadia di Stura, 140  
10156 Torino - ITALY



[www.growrillahydroponics.com](http://www.growrillahydroponics.com)  
[info@growrillahydroponics.com](mailto:info@growrillahydroponics.com)

# WELCOME

## ABOUT US

Growrilla is a 100% Italian brand of hydroponic farming systems, designed and made in Italy by growers for growers.

The project stems from a passion for indoor gardening and a common need for all growers: getting the most out of their plants .

The constant search for information and the desire to experiment with new techniques has led us to hydroponics, an alternative cultivation method to the land. Fascinated by the results obtained from the great potential offered, we decided to propose our own system, the result of direct experience gained over the years, with the aim of offering the grower a functional, easy to use and high performance product.

Growrilla is not simply a system, first of all it wants to be a resource capable of providing the grower with the tools necessary to get the most, because we know that a fast car is not enough to win a race, it is the pilot that makes the difference!

Growing with a Growrilla system also means relying on technical and educational support which, through video tutorials, articles and texts that are constantly updated, will give you all the information you need to achieve the results you are looking for!

## INSTRUCTION MANUAL STEPS

This instruction manual is divided into 5 step, in order to help you for a right assembly of the system. By closely following these instructions you will ensure your system is properly installed and ready to grow!

**STEP 1.** SYSTEM SET UP

**STEP 2.** CONTROLLER POT FITTING KIT

**STEP 3.** AIR DISTRIBUTION SYSTEM

**STEP 4.** TESTING

**STEP 5.** SYSTEM UPGRADE

SYSTEM COMPONENTS

05

ASSEMBLY AND SET UP

09

CONTROLLER POT FITTING

16

AIR DISTRIBUTION

21

SYSTEM TESTING

32

UPGRADE

36

RESET / SYSTEM CLEANING

41





LOGIC OF RDWC SYSTEMS

42

***“Hello and congratulations** for choosing a Gorilla RDWc system. I’m your guide who will help you to assembly and set up your RDWc system. Please read carefully this manual instruction, take your time and try to work in a neat and clean mode, this will ensure to avoid any issues and make a good job!”*



# SIMBOLS

	<i>The presence of this symbol indicates to pay the attention to the subject matter.</i>
	<i>Rotate and screw.</i>
	<i>Lubricate.</i>
	<i>Risk of leakage , pay attention to this step.</i>
	<i>Ceck that everything has been done right.</i>



*Scan this QRcode to download the manual directly on your electronic device.*



## AVVERTENZE DI SICUREZZA

*Questo manuale contiene informazioni molto importanti. Leggere attentamente queste istruzioni prima di iniziare e conservarle per ogni eventualità futura.*

*- GROWRILLA declina qualsiasi responsabilità per utilizzo improprio del prodotto, o per un uso non descritto in questo manuale.*

*- Prima di utilizzare il prodotto per la prima volta, rimuovere tutto l'imballaggio e assicurarsi che il prodotto sia in perfette condizioni. Se così non è, non utilizzare il prodotto e contattare GROWRILLA dal momento che la garanzia copre qualsiasi danno di origine o difetto di fabbrica.*

*- Prima di collegare l'apparecchio alla rete elettrica, assicurarsi che il cavo e la spina siano in perfette condizioni.*

*- Questo apparecchio è inteso esclusivamente per uso domestico. Non esporre il prodotto a condizioni climatiche avverse come pioggia, neve, sole, ecc.*

*- Non tirare mai dal cavo per scollegare l'apparecchio, tirare sempre dalla spina dopo essersi assicurati che l'apparecchio sia spento.*

*- Per la sicurezza dell'utente e per un corretto funzionamento del dispositivo, usare sempre ricambi e accessori GROWRILLA.*

## RICICLAGGIO / SMALTIMENTO



### IMBALLAGGIO

*I materiali di imballaggio dell'apparecchio sono integrati in un sistema di raccolta, classificazione e riciclaggio dei rifiuti. Si prega di smaltirli negli appositi contenitori pubblici.*



### PRODOTTO ELETTRICO/ELETTRONICO

*Questo simbolo indica che, una volta terminato il ciclo di vita del prodotto, se si desidera smaltirlo, non deve essere trattato come rifiuto domestico ma deve essere consegnato presso l'idoneo punto di raccolta per il riciclaggio di apparecchiature elettriche e elettroniche (RAEE). Questo prodotto non contiene concentrazioni di sostanze che potrebbero causare effetti negativi per l'ambiente.*

# SYSTEM COMPONENT

## AREA 1 - SYETEM COMPONENTS



CONTROLLER  
POT PRO 2.0

SI-GRC50VDC19



IN LINE POT  
PRO 2.0

SI-GRC50VPAS19



CONTROLLER LID

SI-GRCOP19



DWC POT LIDS

SI-GRCCOP191F



NET POT 14CM

ID-NETHD014



WATER PROOF 50mm  
RUBBER GASKETS

RC-GSKGGDN50



ELBOW 90 PP  
PUSH FIT D50

RC-PPBG90502B

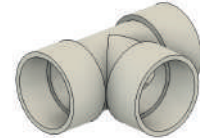

TEE PP PUSH  
FIT D50

RC-PPBT90502B



PVC PIPE DN50  
L 10 15 30 40

TU-PVC50010  
TU-PVC50015  
TU-PVC50030  
TU-PVC50040



RETURN TEE D50  
L 40 X 1"

SI-GRC50TR40D



VALVE 1"  
MALE FEMALE

RC-VALPVCDMF



O RING 1" 1/4

RC-GSKORDM



COMPACT VALVE 1"  
MALE FEMALE

RC-VALDMF



IN LINE FILTER 1"

IR-FLTD50B



RETURN HOSE  
20MM

TU-PVCGFP25

---

--

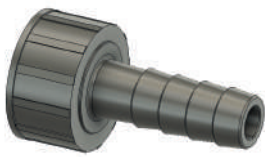

BARBED FITTING  
1" 20X1" F

RC-PG20DGM

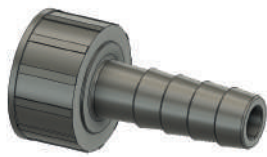

BARBED FITTING  
20X3/4" F

RC-PG20CGM



BARBED FITTING  
20X3/4" M

RC-PG20CM



THREADED TEE  
3/4" FFF

RC-FILTECCFFFGM

## AREA 2 - CONTROLLER POT COMPONENTS



EXT. TRHEADED  
FITTING 3/4" MALE

RC-FILPRLCMM



THREADED ELBOW  
90 3/4" FF

RC-FIL90CCFFGM



BULKHEAD 3/4"

RC-ATSPC



WATER PUMP  
EDEN 135TB

ID-PAC135TB



VENTURI ELBOW

SI-GRC90CGMV

## RACCORDI INGRESSO / USCITA SISTEMA - CHILLER IN/OUT



ELBOW BARBED  
FITTING 16X3/4" FEM

RC-PG90CGM



BARBED FITTING  
MALE 16 X 3/4"

RC-PG16CM



# SYSTEM COMPONENT

## AREA 3 - AIR DISTRIBUTION SYSTEM



AIR HOSE  
6X4MM

TU-SILO604100



AIR HOSE  
12X8MM

TU-PVCTH0812



PVC AIR HOSE  
6X4MM L30CM

PVC64030



AIR GASKETS  
6MM

RC-GSKPT1006



AIR ELBOW FITTING  
3X5MM

RC-PG900305



AIRMANIFOLD 12X6  
1 WAY OUT

RC-PGMU1206U1



AIRMANIFOLD 12X6  
2 WAY OUT

RC-PGMU1206U2



AIRMANIFOLD 12X6  
4 WAY OUT

RC-PGSMU1206U4



END CAP 12MM

RC-PGSTAP012



AIR STONE

ID-POR1002020B



AIR DISTRIBUTION  
PIPE 12 X9MM

TU-PEN12050B  
TU-PEN12060B  
TU-PEN1205100B



PORTAGOMMA  
A GOMITO 10MM

RC-PG9010



AIR PUMP HAILEA  
V SERIES

ID-PARV30  
ID-PARV60



AIR PUMP  
ET SERIES

ID-PARET30  
ID-PARET40  
ID-PARET80  
ID-PARET100



L60/100

AIR JOINT  
3/4 ROWS

SI-GRC50GCA3F  
SI-GRC50GCA4F



## AREA 4 - ADDITIONAL COMPONENTS



FLEXIBLE STORAGE  
TANK

ID-CONTF098  
ID-CONTF157  
ID-CONTF225  
ID-CONTF500  
ID-CONTF700



CONNECTION  
QUICK FITTING

SI-GRCTF16MT2



FLOAT VALVE

ID-VALG12178



TUBO FLESSIBILE  
PVC DN16

TU-PVCGFP16



EXTENSION FOR  
DELIVERY MANIFOLD A

SI-GRC50MMAPR



EXTENSION FOR  
DELIVERY MANIFOLD B

SI-GRC50MMBPR



CHILLER KIT  
WATER PUMP

ID-PACCHJ600  
ID-PACCHJ800  
ID-PACCHJ1500

# SYSTEM INSTALLATION

## STEP 1 SYSTEM INSTALLATION

**a) Unbox.** Place all parts adjacent to the grow area and keep all the components separately. All the components are divided by type, this will make it easy to recognize them and will help you to understand where they have to be used.

**b) Gaskets.** Insert the water proof gaskets 50mm inside the hole at the bottom of the buckets, making sure to put them with the FRONT writing on the outside of the pots.



**LUBRICATE.** use a bit of soap or other lubricant will help you to insert the gaskets inside the holes

RC-GSKGGDN50



**c)** put all the pots on the floor of your grow area , looking at the shape of your system ( 2, 3 or 4 rows) and with the air hole in the same position as shown in the picture below.

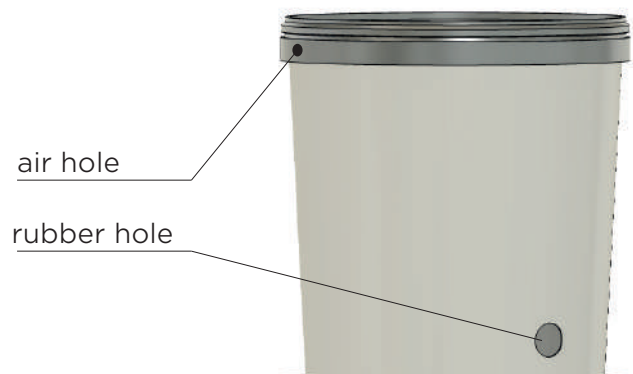

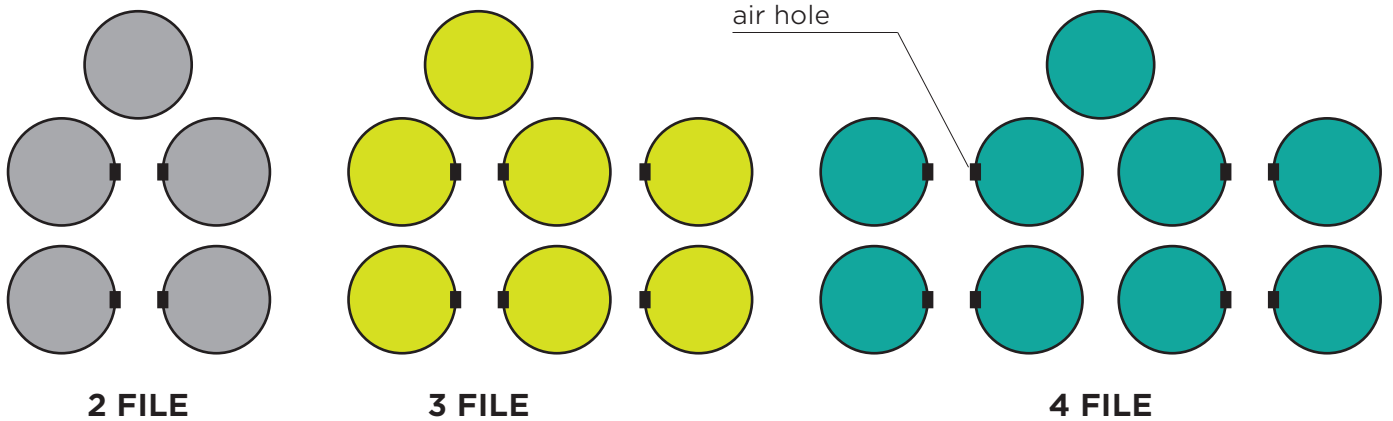

**d)** now you are able to start to insert the connection pipes inside the gaskets.

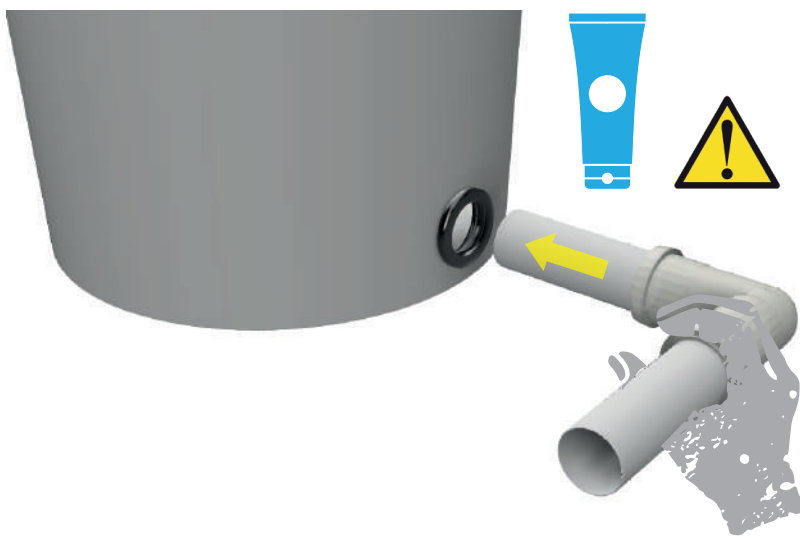

**Gasket.** lubricate the internal side of the gaskets and the PVC pipe before insert them

**How to fit the pipe.** insert the pipe inside the gasket simply sliding it inside them.

**e) Delivery and return manifold.** The return and delivery manifolds are made with PVC pipe and PUSH FIT FITTING, they are easy to assemble and disassemble. Refer to the shape of your system to assemble the manifolds, as shown below.

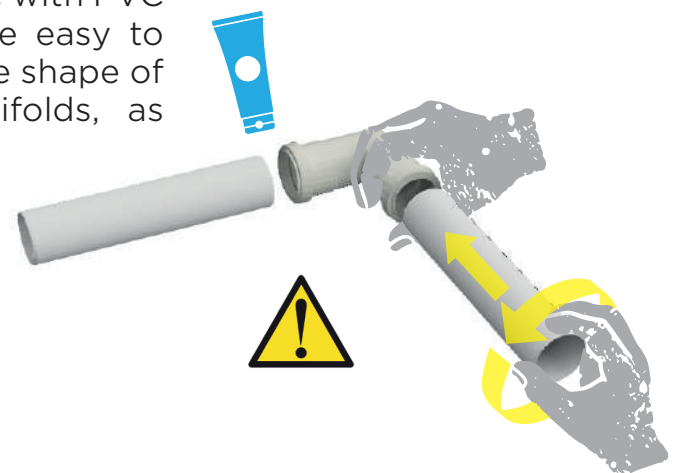

**Fat Fitting.** they are easy to assemble and disassemble. Refer to the shape of your system to assemble the manifolds, as shown below.

# DELIVERY MANIFOLD ASSEMBLY

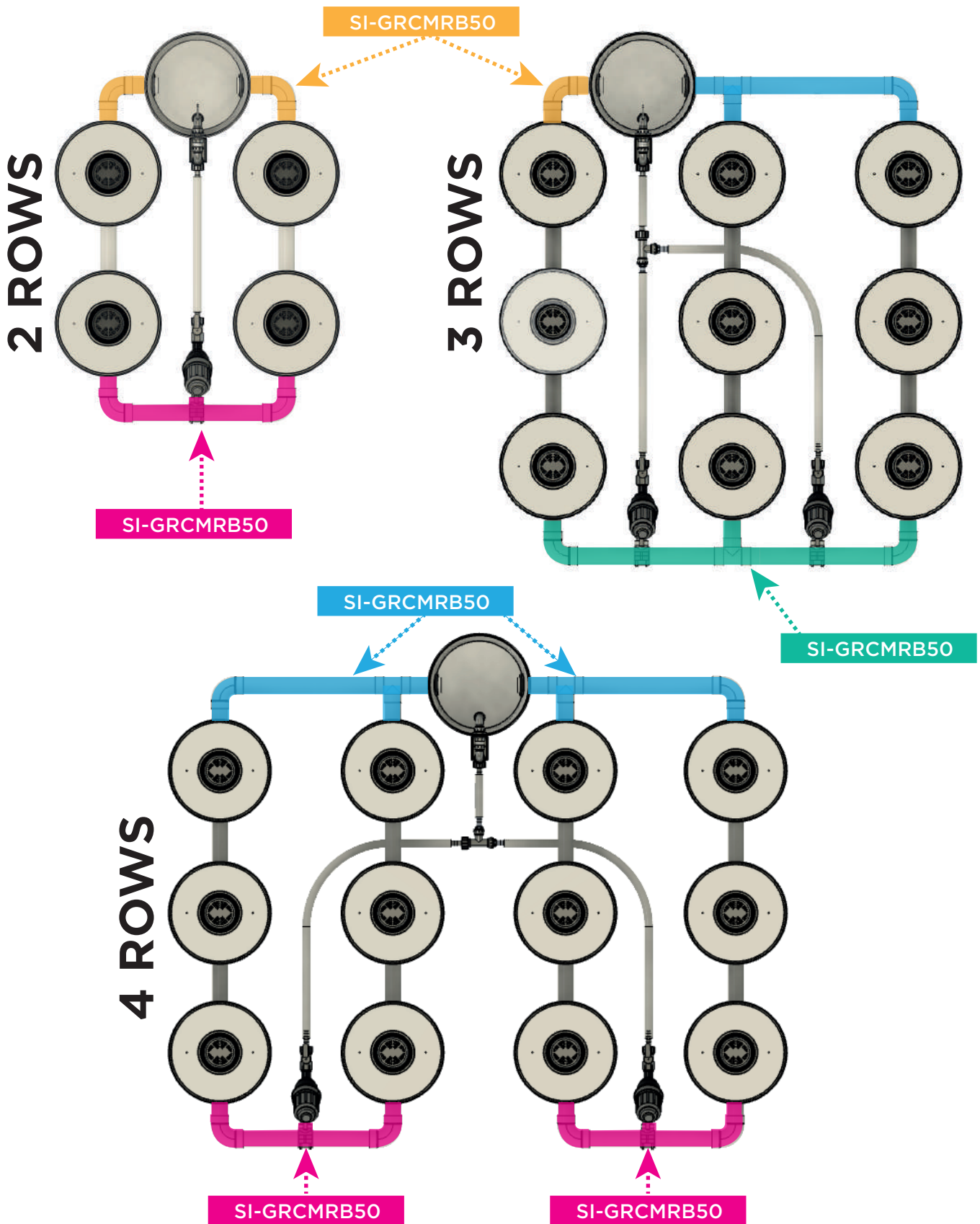

f) Assembly diagrams DELIVERY MANIFOLD.

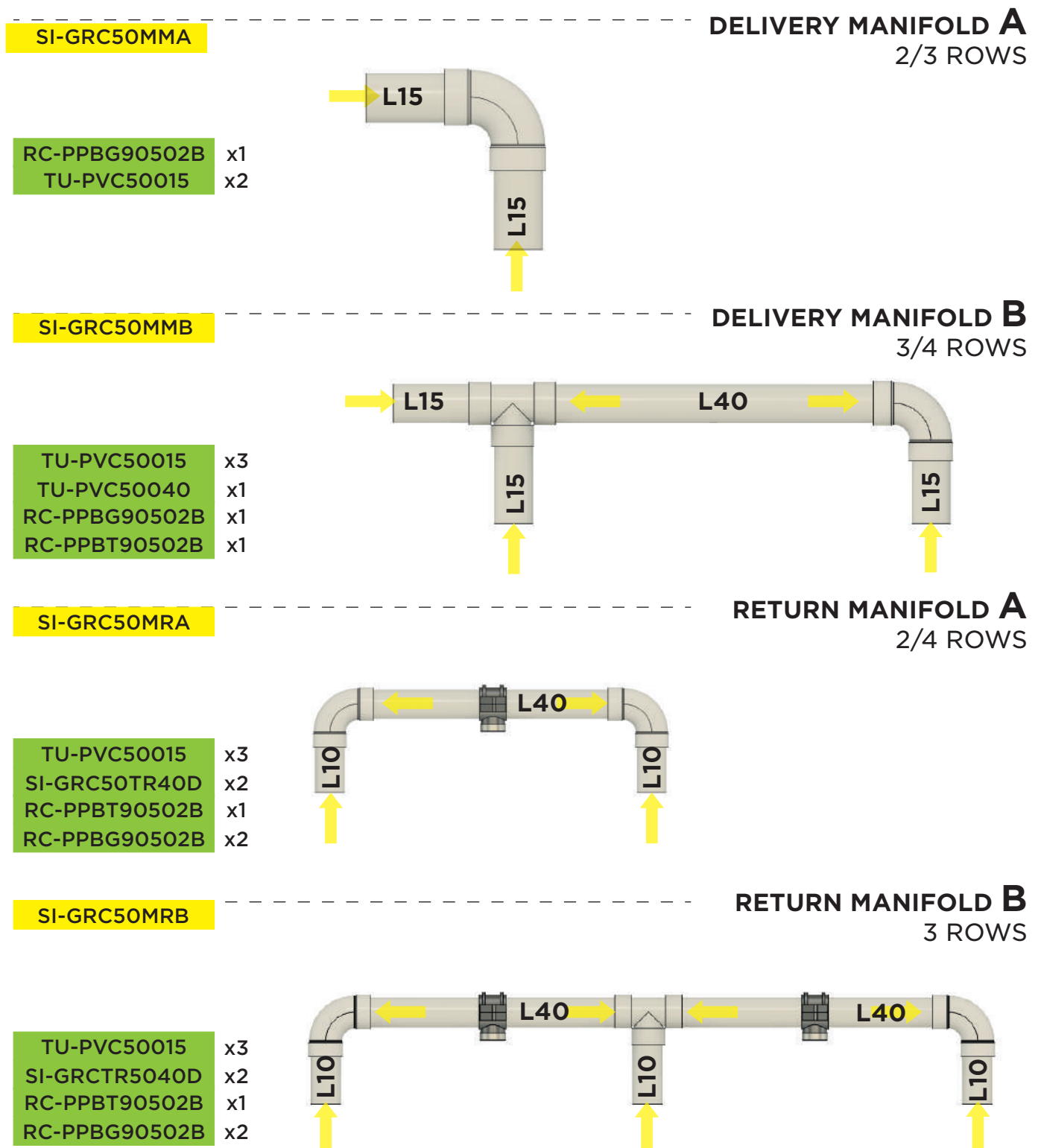

# 2 ROWS RDWC SYSTEM

**g) DELIVERY MANIFOLD FOR 2/ ROWS SYSTEM.** connect the controller pot to the first two growing pot.

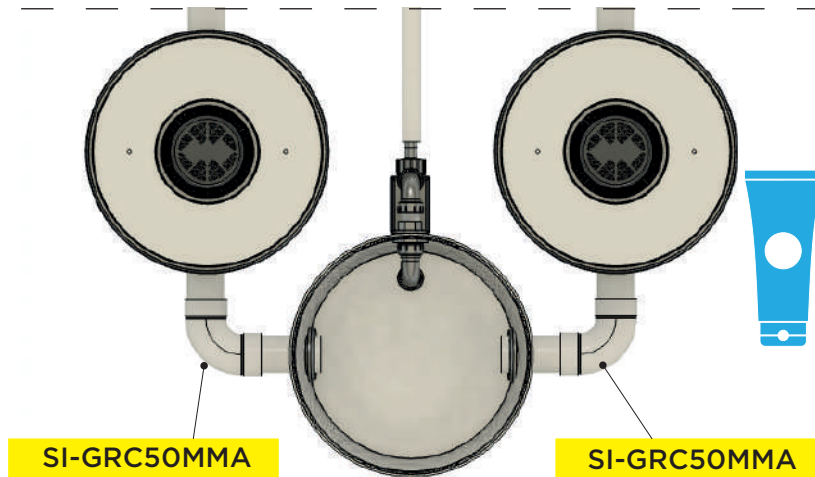

**h) Growing Pot Connection .**



**D I S T A N C E**  
**B E T W E E N P O T S:**  
the distance between pots can be adjusted simply sliding the pipes inside the pots ( please keep minimum 3 cm of pipe inside the the pot)

**i) RETURN MANIFOLD FOR 2 ROWS SYSTEM.** connect the last two pots at the back of the system with the relative RETURN MANIFOLD

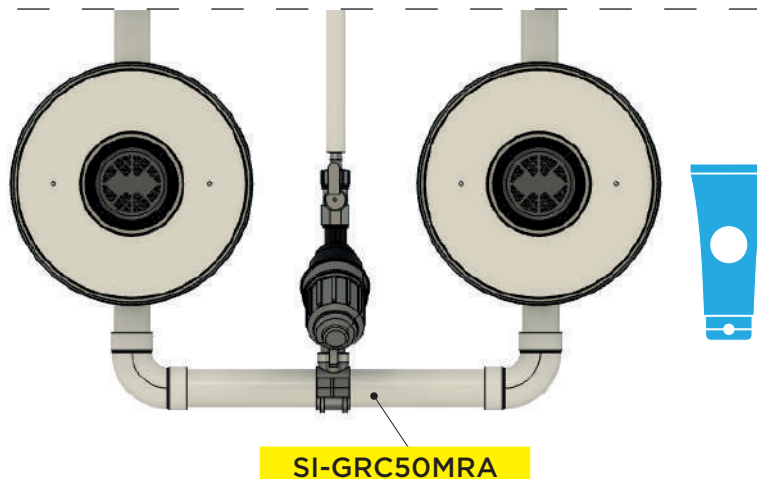



# 3 ROWS RDWC SYSTEM

**I) DELIVERY MANIFOLD FOR 3/ ROWS SYSTEM:** connect the controller pot to the first 3 growing pots . Use the component SI-GRC50MMB to connect the growing pot 1 and 2. Use the component SI-GRC50MMA to connect the growing pot 3.

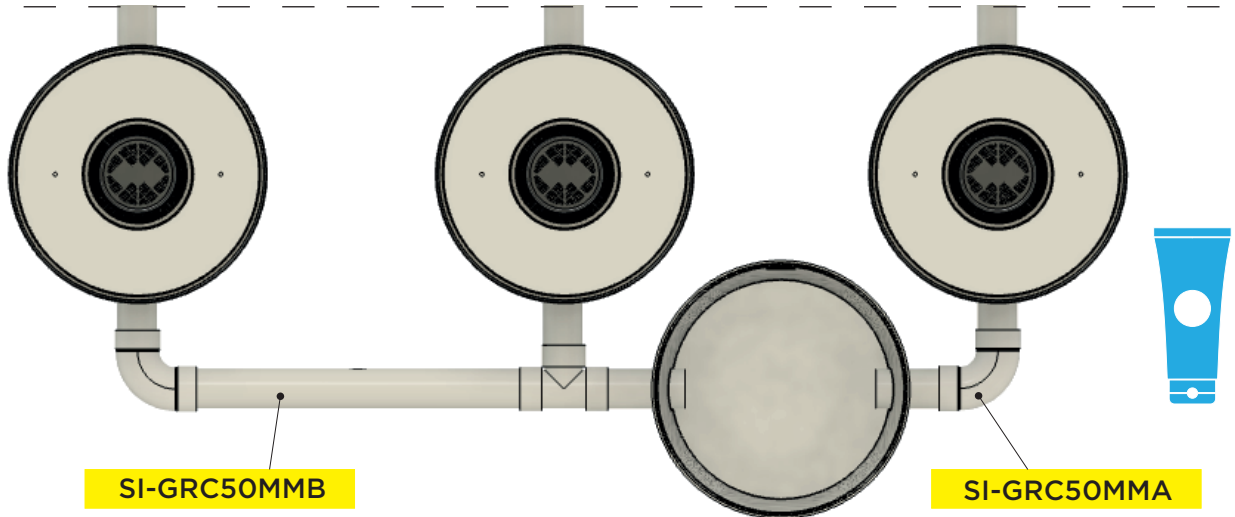

**m) Growing Pot Connection .**



**D I S T A N C E  
B E T W E E N P O T S:**  
the distance between pots can be adjusted simply sliding the pipes inside the pots ( please keep minimum 3 cm of pipe inside the the pot)

**n) RETURN MANIFOLD FOR 3 ROWS SYSTEM.** connect the last three pots at the back of the system with the relative RETURN MANIFOLD ( SI-GRC50MRB)

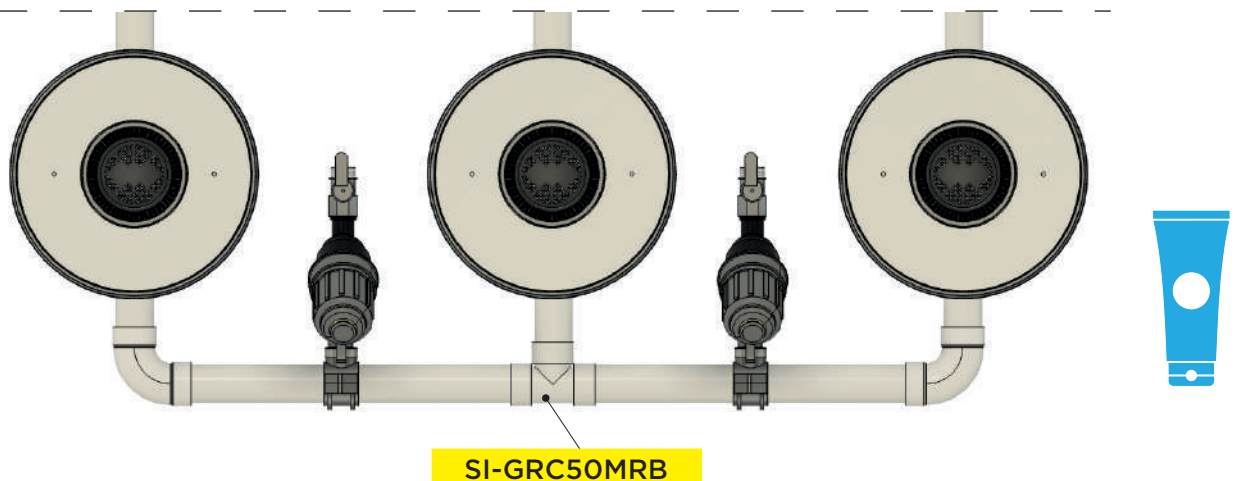



# 4 ROWS RDWC SYSTEM

**o) DELIVERY MANIFOLD FOR 4/ ROWS SYSTEM.** connect the controller pot to the first 4 growing pots . Use the two components SI-GRC50MMB to connect the growing pot 1 and 2, then connect the pots 3 and 4

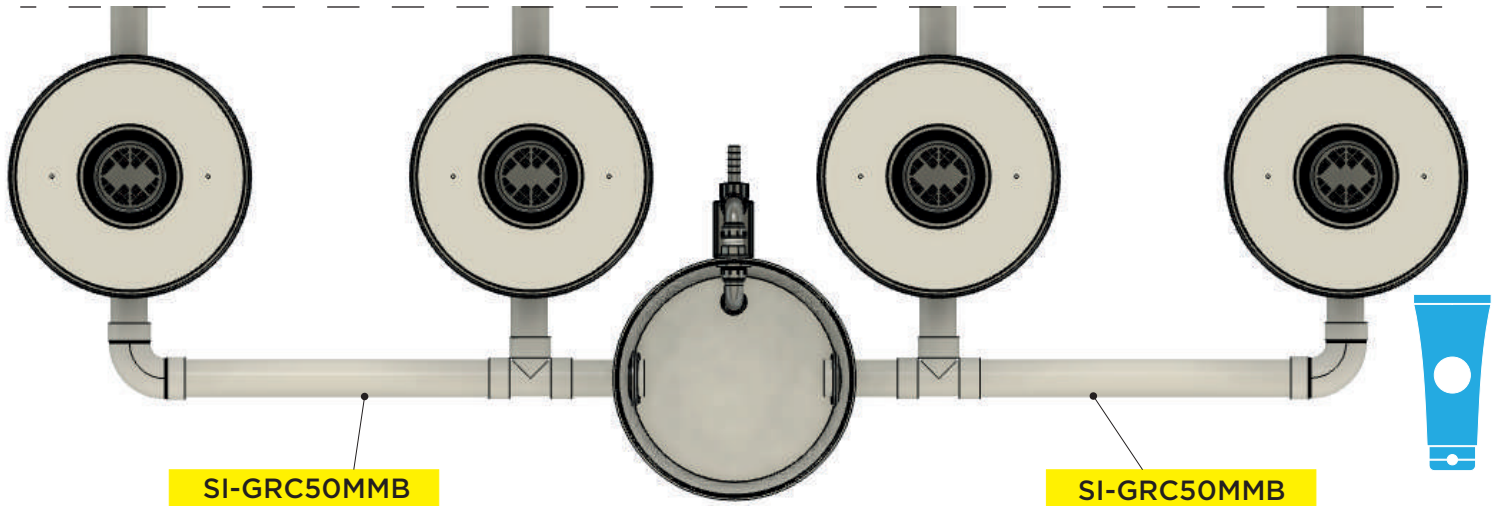

**p) Growing Pot Connection .**

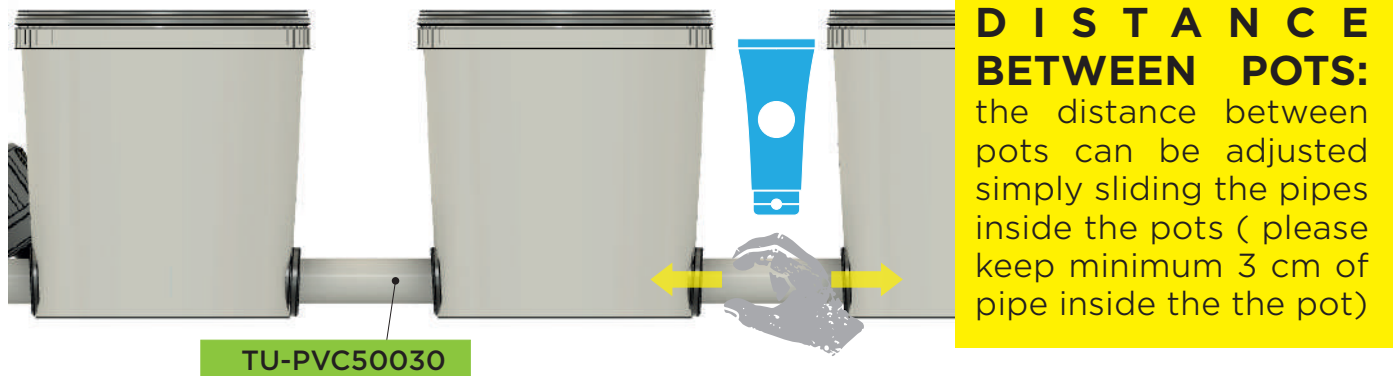

**q) RETURN MANIFOLD FOR 4 ROWS SYSTEM.** connect the last four pots at the back of the system with the two relative RETURN MANIFOLD ( SI-GRC50MRa)

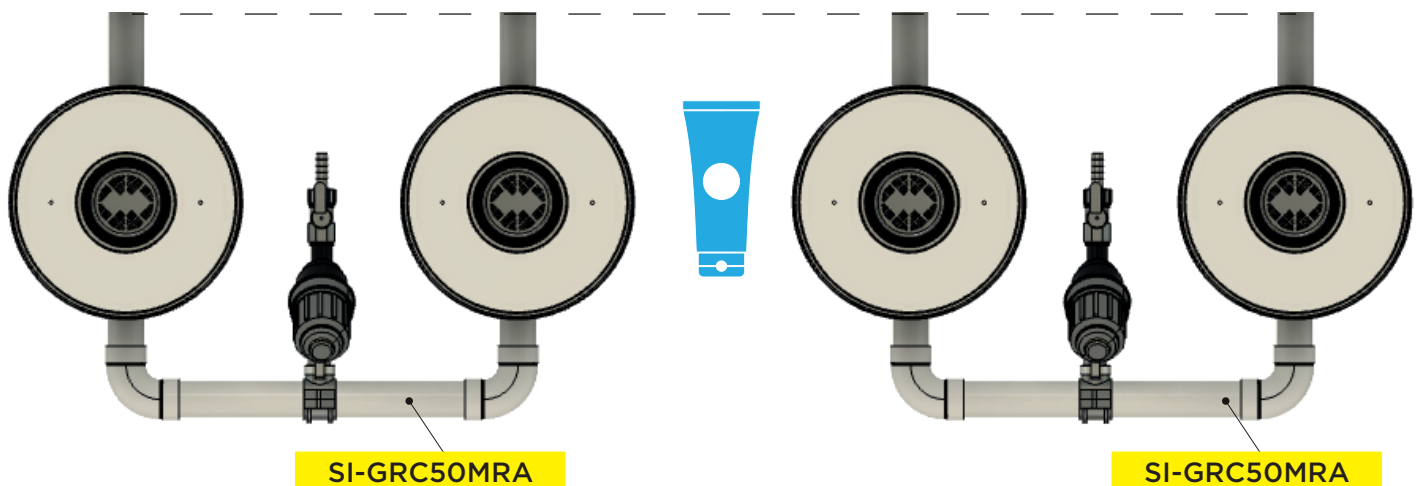

# CONTROLLER POT FITTING KIT

## STEP 3 CONTROLLER POT FITTING KIT

**a) Unbox.** Keep the controller pot fitting bag and start the assembly.

**b) Water Pump.** Screw the extension tube and the elbow threaded fitting as shown in the figure.

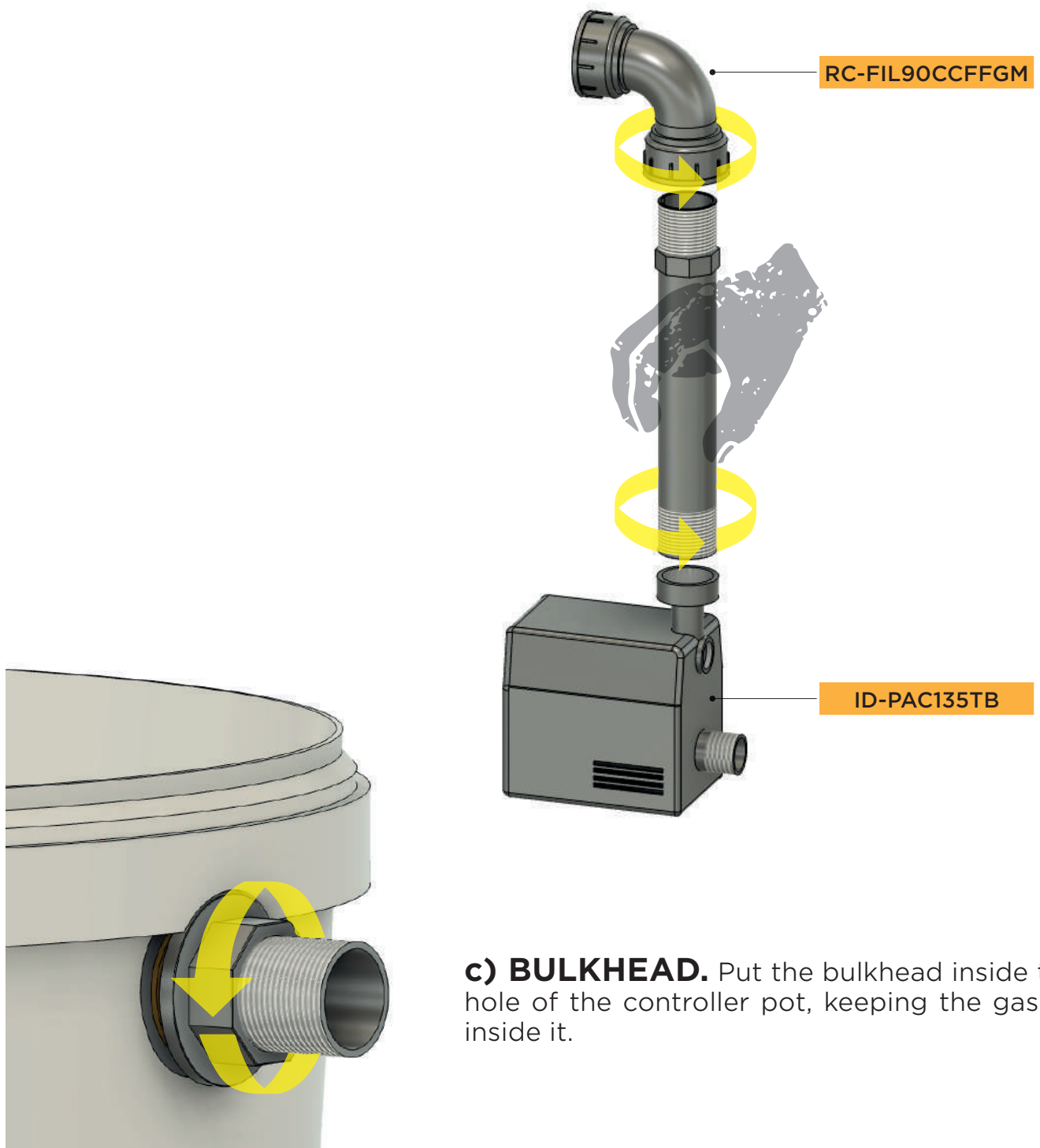

**c) BULKHEAD.** Put the bulkhead inside the hole of the controller pot, keeping the gasket inside it.

# CONTROLLER POT FITTING KIT

**d)** Screw the VENTURI ELBOW and the other EXTENSION TUBE to the internal side of the controller pot.

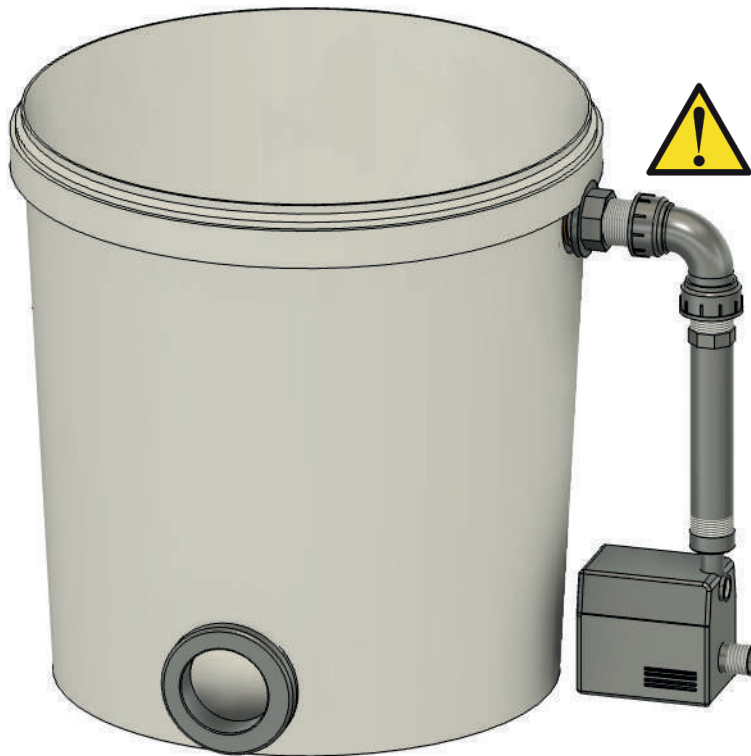

**Note.** Make it sure that all the fitting are well screwed.

**Water Pump.** Make sure the water pump is perfectly set on the ground.

**e) Venturi Elbow.** this component is designed for mixing the water from the pump with the air in order to keep the water inside the controller pot well oxygenated. Once the system is filled with water, operate the pump and adjust the VENTURI air tube until the Venturi effect is triggered. If everything is done correctly you will see bubbles appear in the control pot

**Venturi.** Connect the venturi elbow inside the control pot.

SI-GRC90CGMV

RC-FILPRLCMM

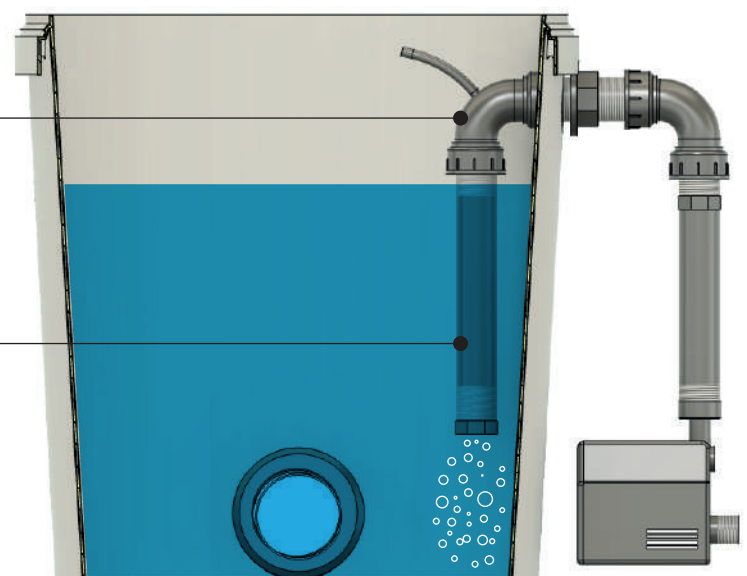

# RETURN HOSE KIT

SI-GRC50FVDK

RC-GSKORDM x1  
RC-VALPVCDFM x1  
IR-FLTD50B x1  
RC-VALDMF x1

**ORING.** remember to put the o'ring on the male thread of the valve.

KIT FILTRO CON VALVOLA 1"

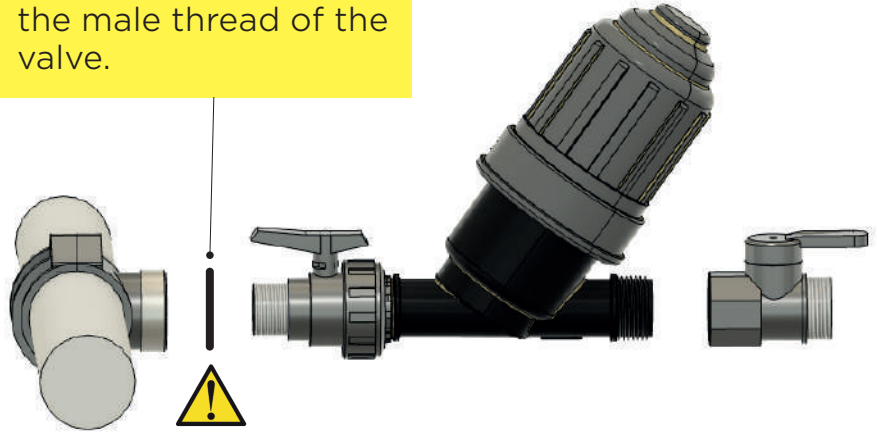

**f)** Screw the FILTER + VALVE KIT inside the RETURN TEE then connect the water sucking hose to the second valve. Make sure that the two valves are tightly screwed.

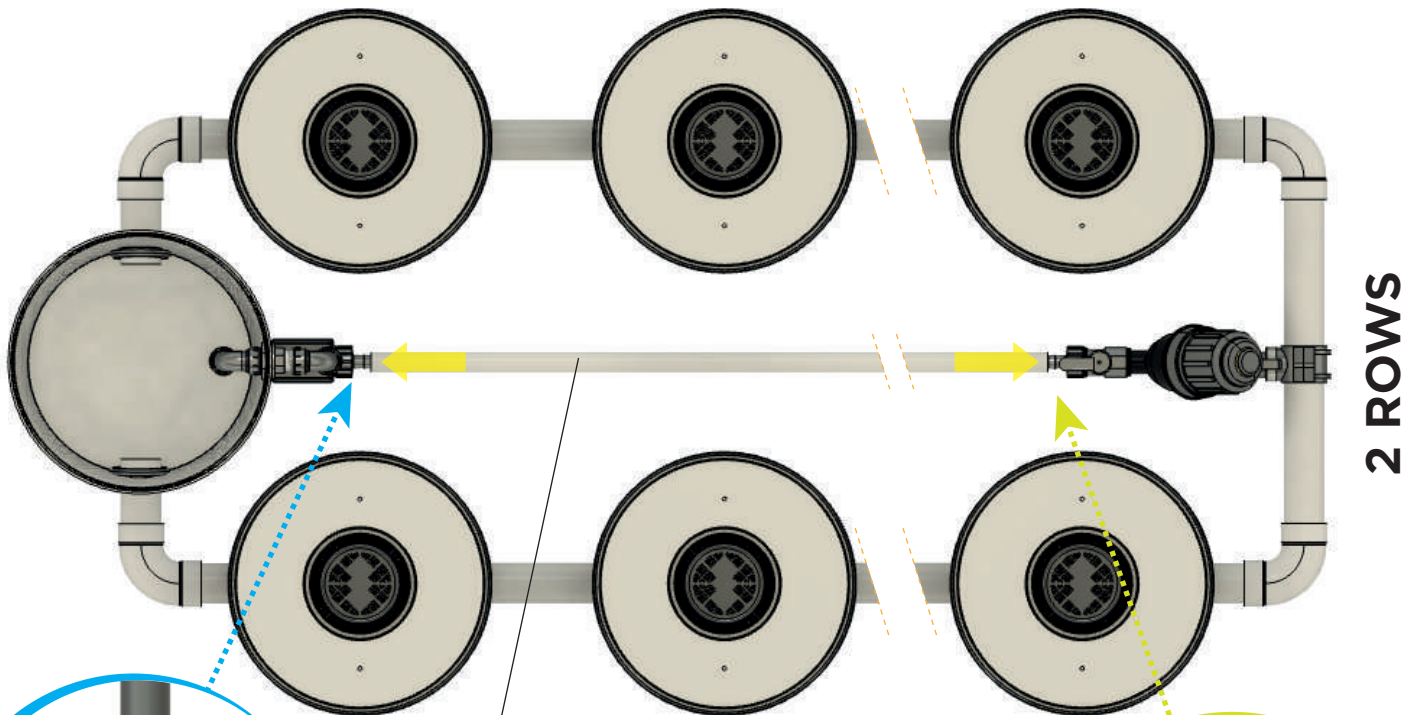

**RETURN HOSE.** length is variable according to the number of pots involved.

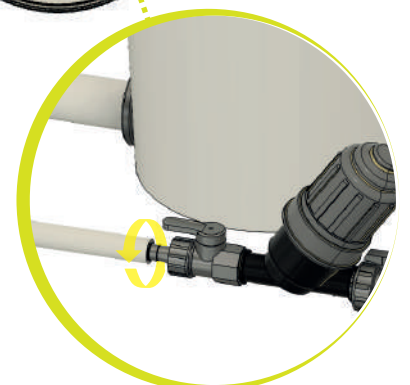
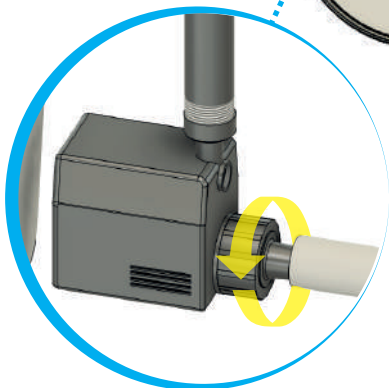

# RETURN HOSE KIT

**g)** Nel sistema a 3 FILE i due tubi di aspirazione dei moduli di Ritorno rimangono i medesimi, a variare di lunghezza sarà la dorsale principale che va dal Tee al vaso di controllo.

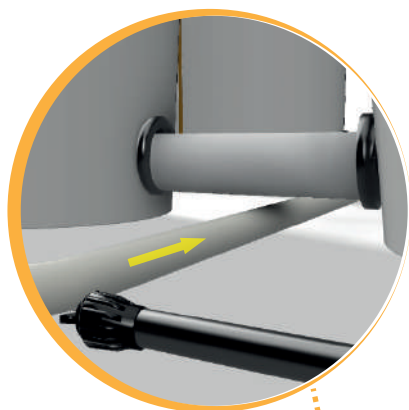

## Aspirazione.

La lunghezza di questo componente varia in base al numero di vasi posati.

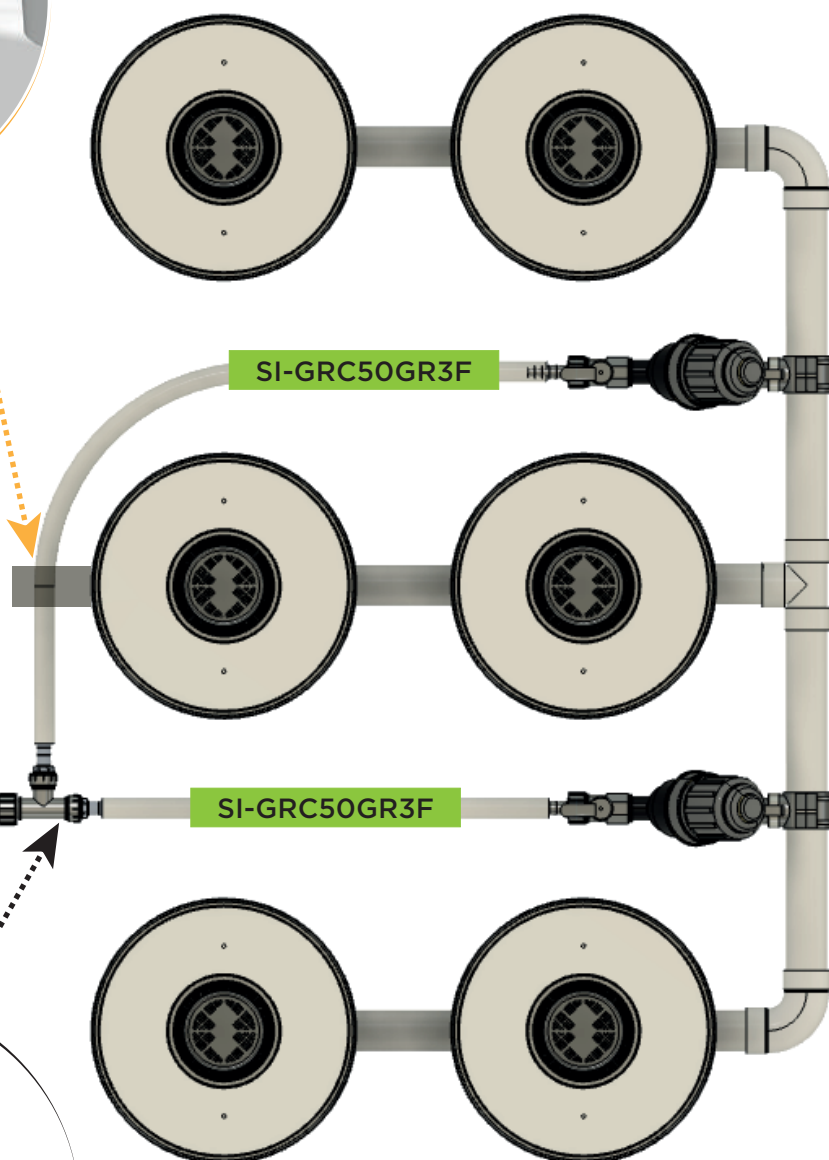
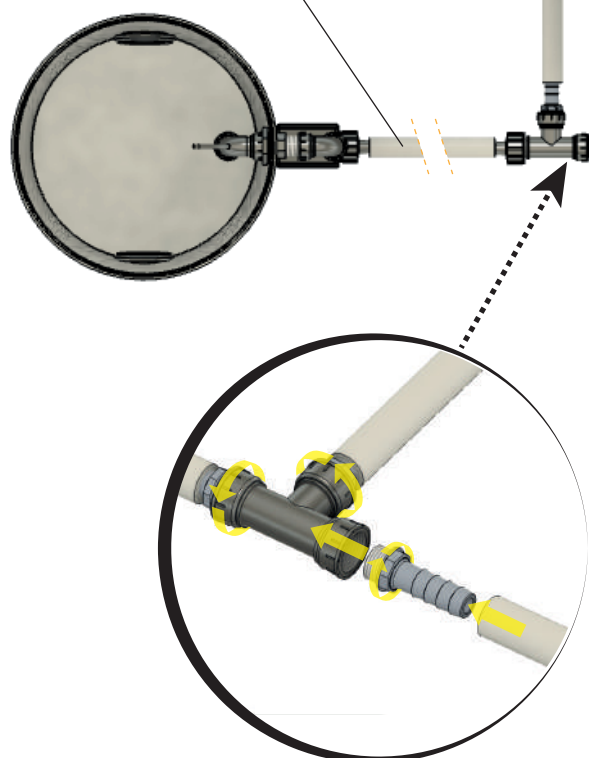



**h)** Nel sistema a 4 FILE i due tubi di aspirazione dei moduli di Ritorno rimangono i medesimi, a variare di lunghezza sarà la dorsale principale che va dal Tee al vaso di controllo.

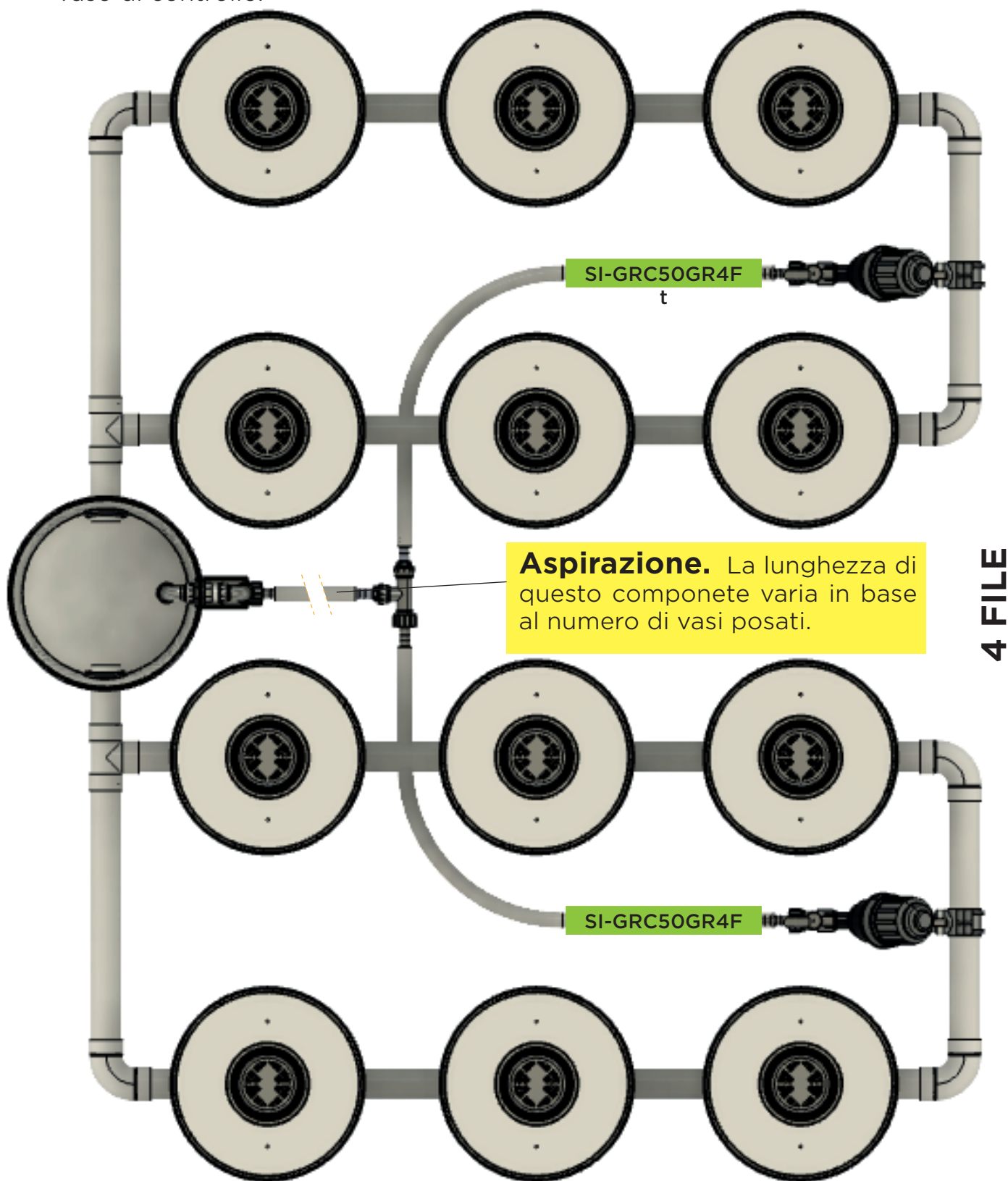

# DISTRIBUTION AIR LINE KIT

## STEP 3 AIR DISTRIBUTION

**a) Unbox.** Take all the components of your AIR DISTRIBUTION KIT and put them together, you will be able to recognise all the pieces are shown below

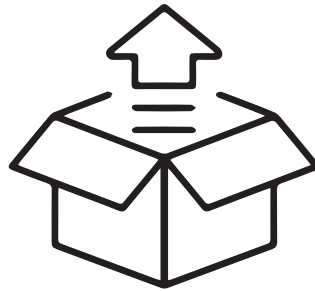

**b) Air Pump.** Place the air pump.

**Pump.** Place the air pump above the system water level.

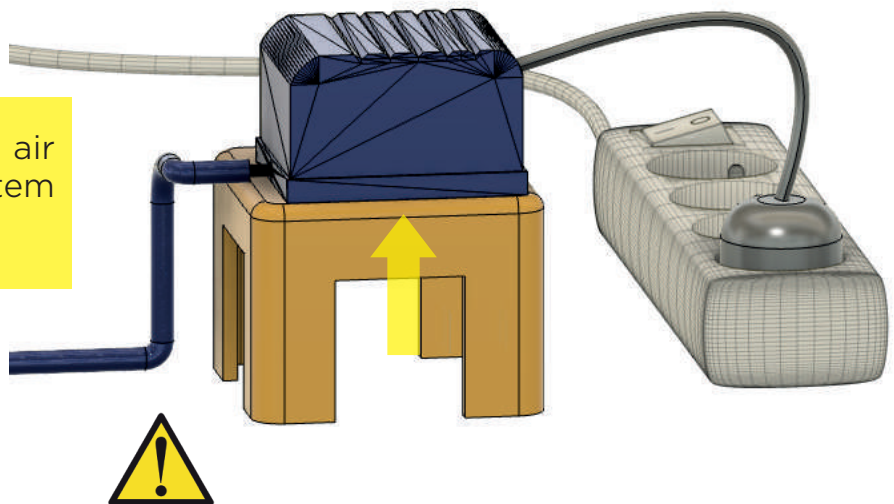

**e) AIR GASKETS.** place all the air gasket in the little hole you find in the upper edge of the growing pots

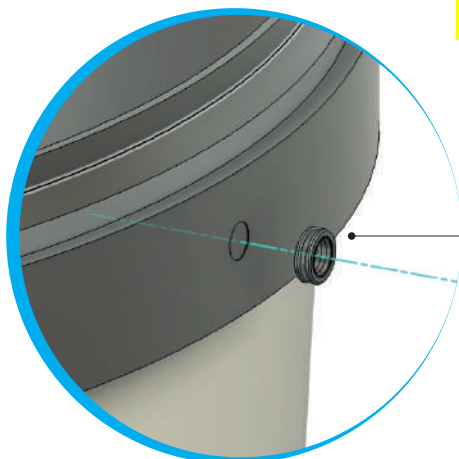

RC-GSKPT10X06



**c) AIR JOINT** . For 3/4 Row systems we **have** pre-assembled the tail joints to facilitate your work, here below the two versions.

**L60**



**SI-GRC50GCA3F**

**3 ROWS**

**L100**



**SI-GRC50GCA4F**

**4 ROWS**

**d)AIRHOSE 12X8mm.**

It's used to connect the air distribution line to the air pump.

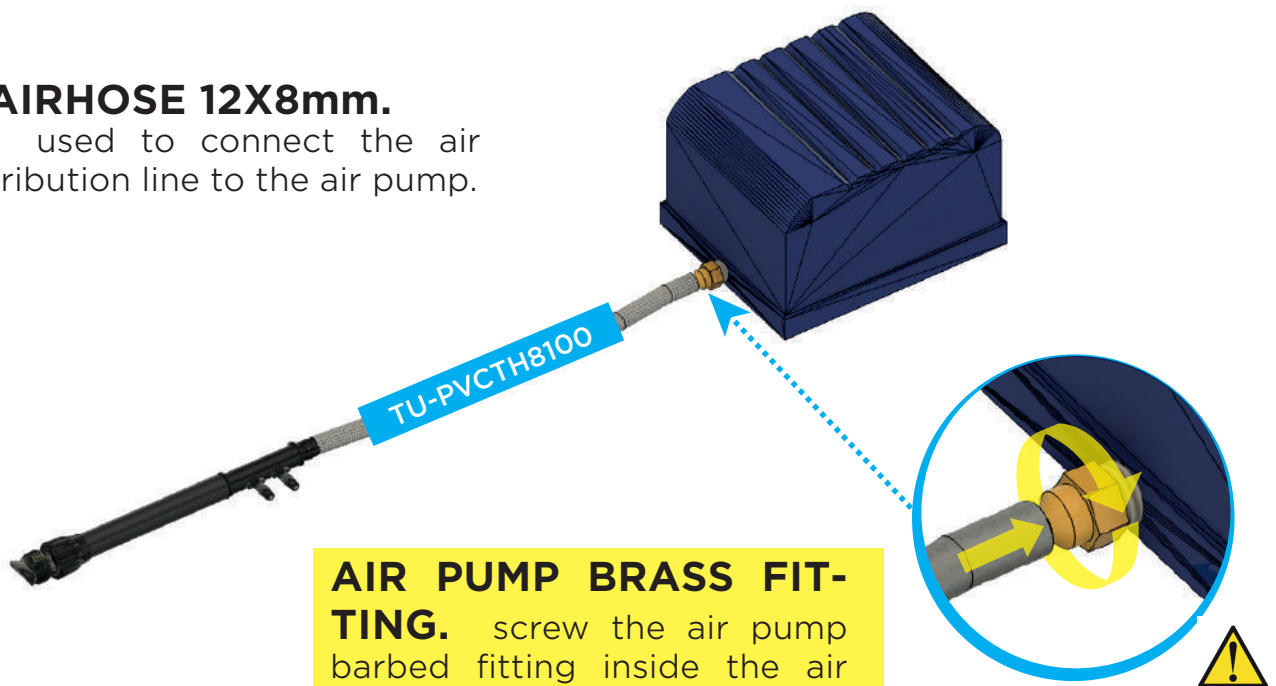

**AIR PUMP BRASS FITTING.** screw the air pump barbed fitting inside the air pump outlet.

# DISTRIBUTION AIR LINE KIT

**e) AIR MANIFOLD ( 4 WAY OUT).** Air manifolds are used to bring air from the main distribution line to every growing pot. End cap and the air manifold 4 way out it come with the swivel lock system, and have to be assembled as shown in the picture below.

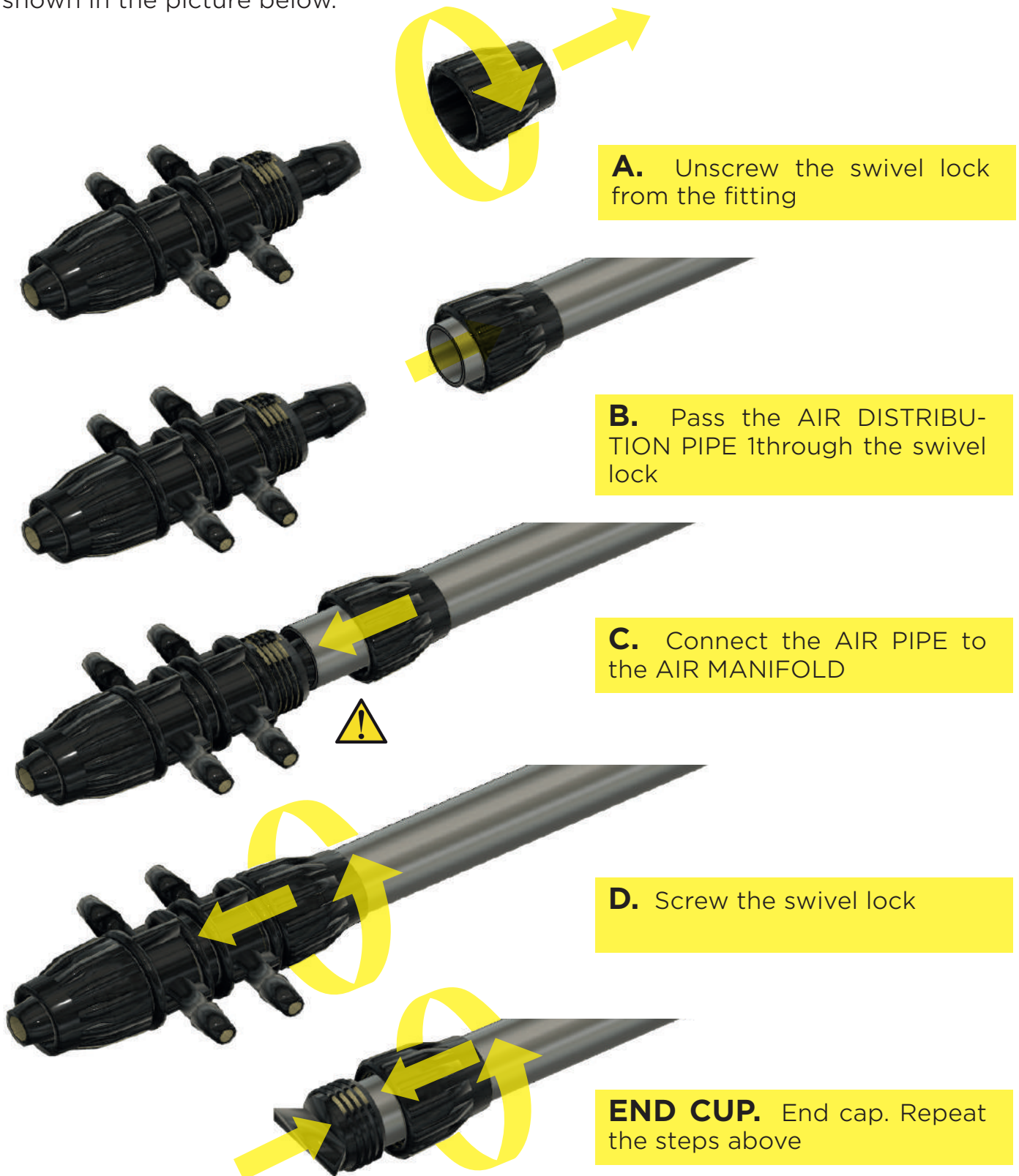

**f) AIR DISTRIBUTION LINE.** Complete the air distribution line following the diagrams shown below. Search for your system diagram, every system has a different distribution line according to the number of pots involved.

### RDWC 4 - 2 ROWS

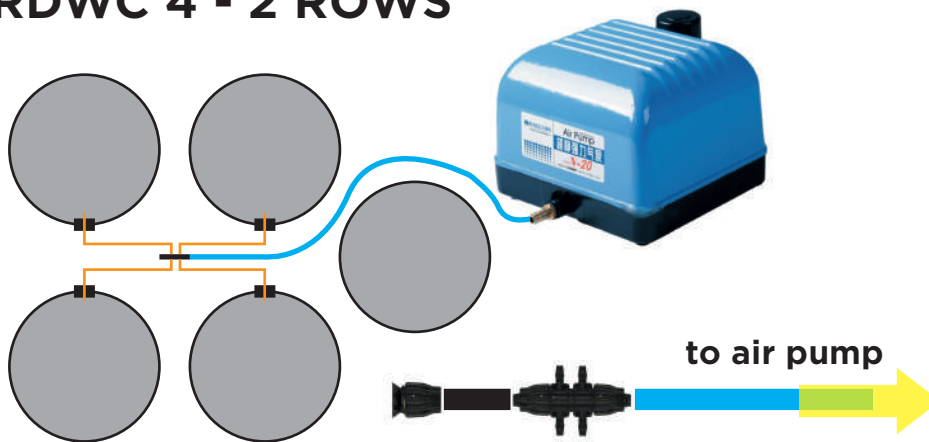

AIR PUMP  
V-30

ID-PARV30

RC-PGSMU1206U4 x1

RC-PGSTAP012 x1

TU-PVCTH0812 x1

### RDWC 6 - 2 ROWS

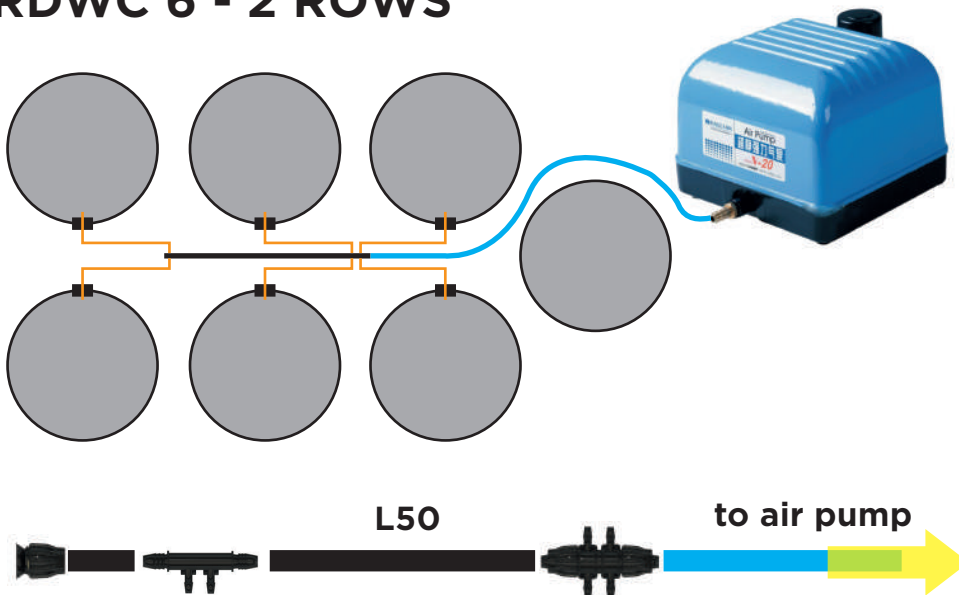

AIR PUMP  
V-30

ID-PARV30

RC-PGSMU1206U4 x1

RC-PGMU1206U2 x1

RC-PGSTAP012 x1

TU-PEN12050B x1

TU-PVCTH0812 x1



# DISTRIBUTION AIR LINE KIT

## RDWC 8 - 2 ROWS

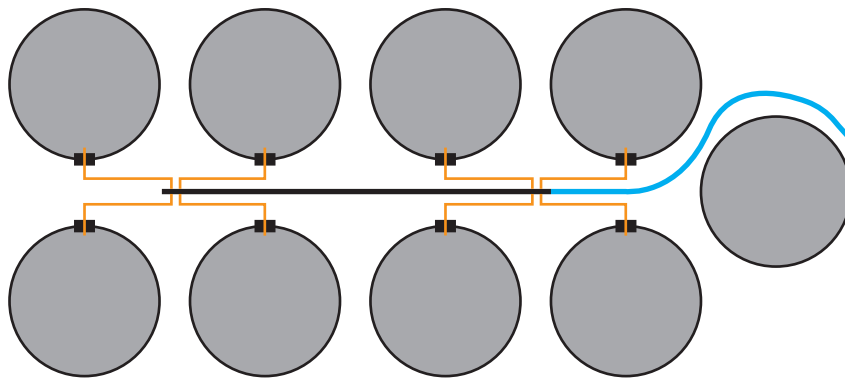

AIR PUMP  
ET40

ID-PARET40

- RC-PGSMU1206U4 x2
- RC-PGSTAP012 x1
- TU-PEN12100B x1
- TU-PVCTH0812 x1



## RDWC 9 - 3 ROWS

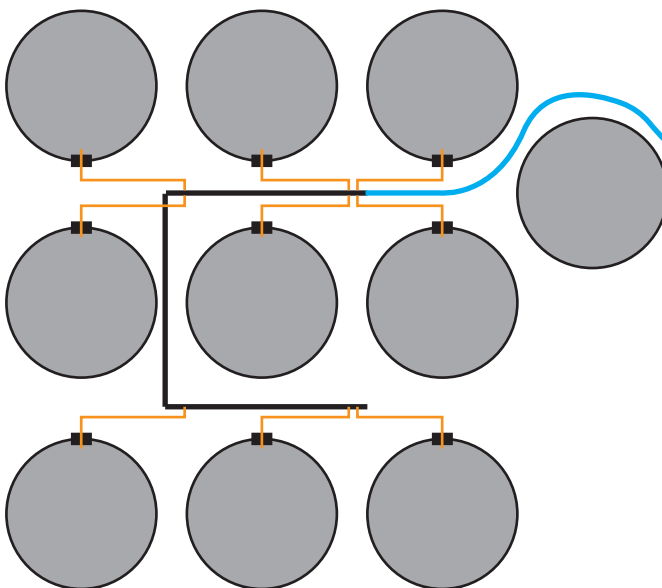

AIR PUMP  
ET40

ID-PARET40

- RC-PGMU1206U1 x1
- RC-PGMU1206U2 x2
- RC-PGSMU1206U4 x1
- RC-PGSTAP012 x1
- SI-GRC50GCA3F x1
- TU-PEN12050B x2
- TU-PVCTH0812 x1

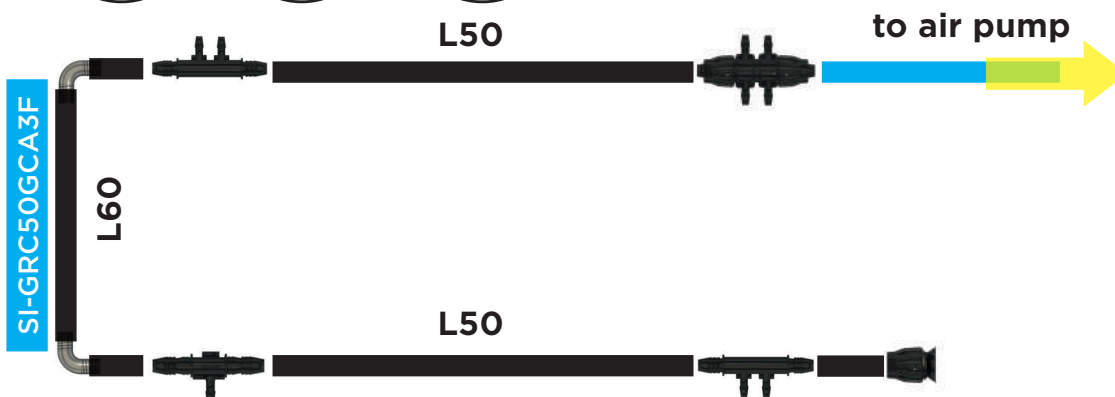

SI-GRC50GCA3F

L60

L50

L50

to air pump

## RDWC 12 - 3 ROWS

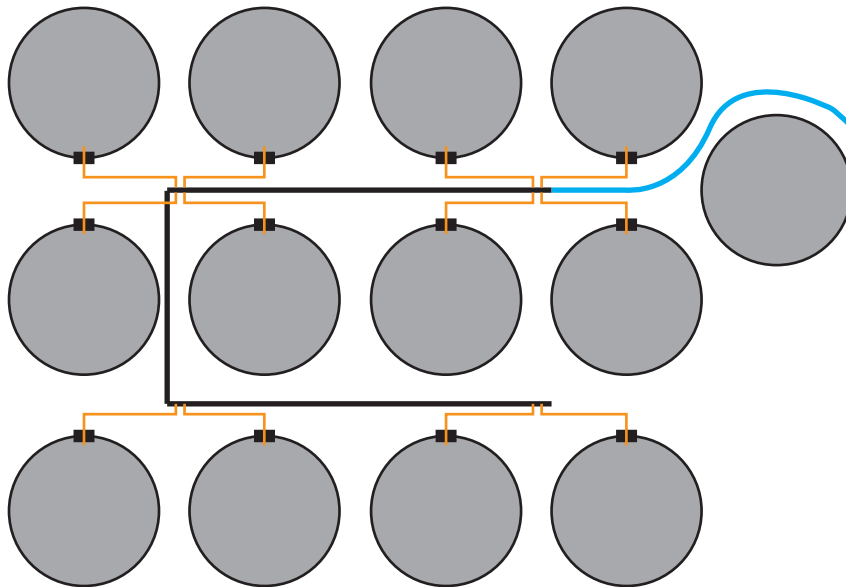

AIR PUMP  
V-60

ID-PARV60

- RC-PGMU1206U2 x2
- RC-PGSMU1206U4 x2
- RC-PGSTAP012 x1
- SI-GRC50GCA3F x1
- TU-PEN12100B x2
- TU-PVCTH0812 x1

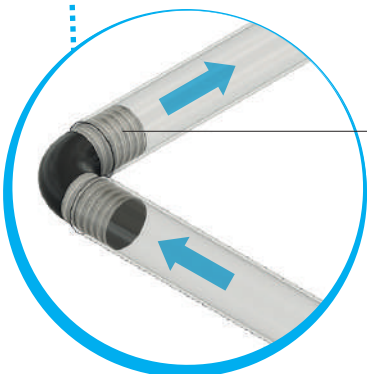
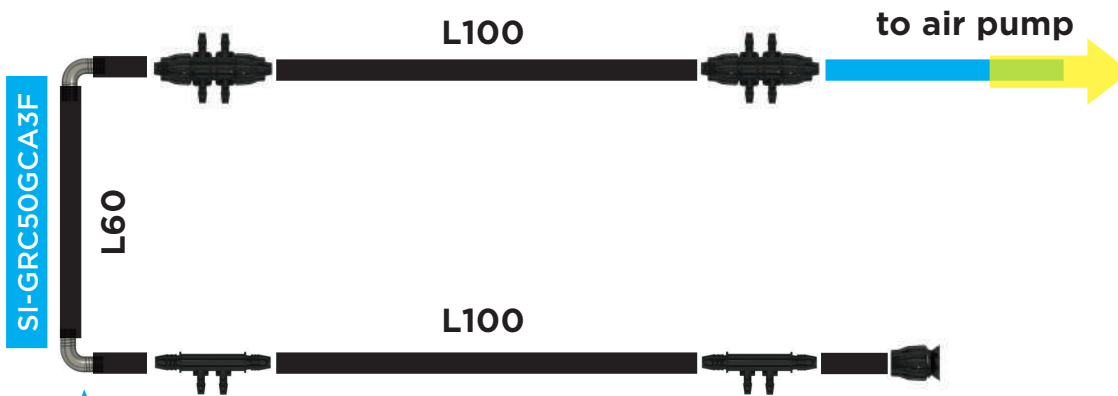

GOMITO ARIA 11MM  
RC-PG9010



TAPPO ARIA 11MM  
RC-PGSTAP012

# DISTRIBUTION AIR LINE KIT

## RDWC 12 - 4 ROWS

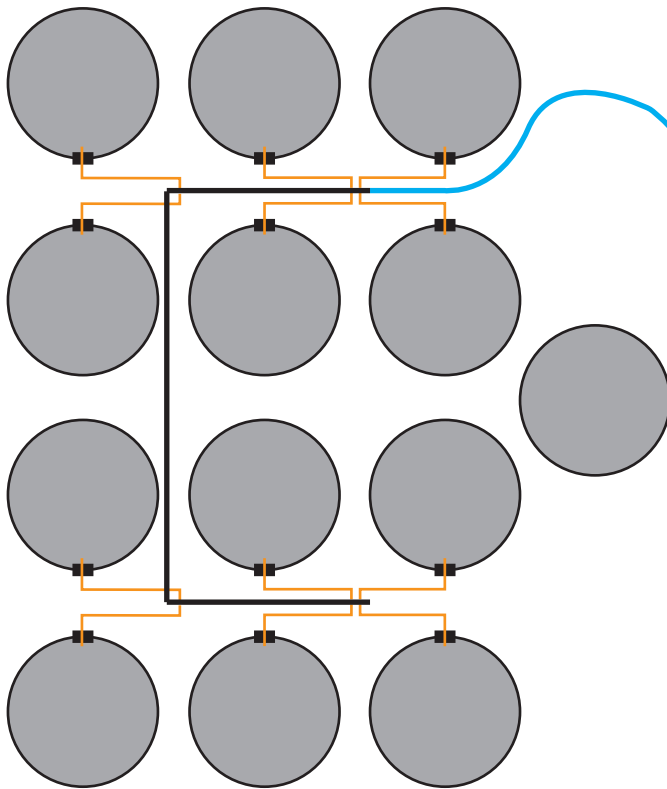

AIR PUMP  
V-60

ID-PARV60

- RC-PGMU1206U2 x3
- RC-PGSMU1206U4 x3
- RC-PGSTAP012 x1
- SI-GRC50GCA4F x1
- TU-PEN120050B x4
- TU-PVCTH0812 x1

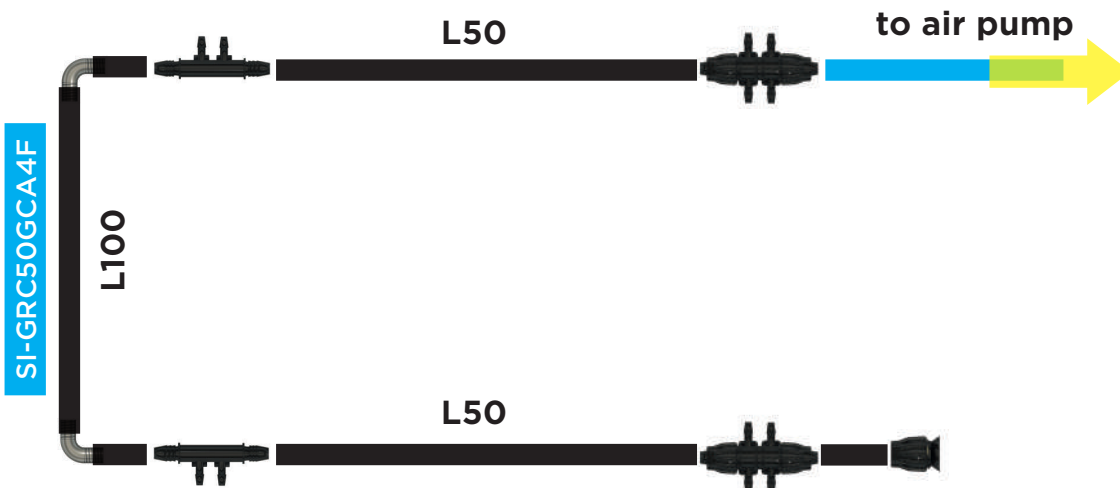

# RDWC 16- 4 ROWS

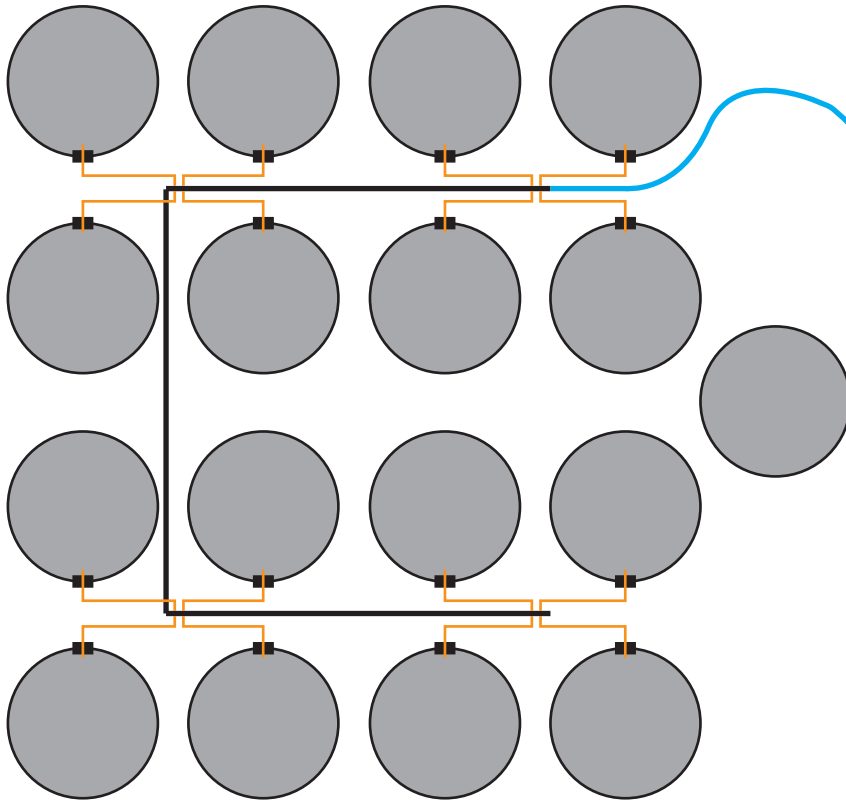

AIR PUMP  
V-60

ID-PARV60

- RC-PGSMU1206U4 x4
- RC-PGSTAP012 x1
- SI-GRC50GCA4F x1
- TU-PEN12100B x2
- TU-PVCTH0812 x1

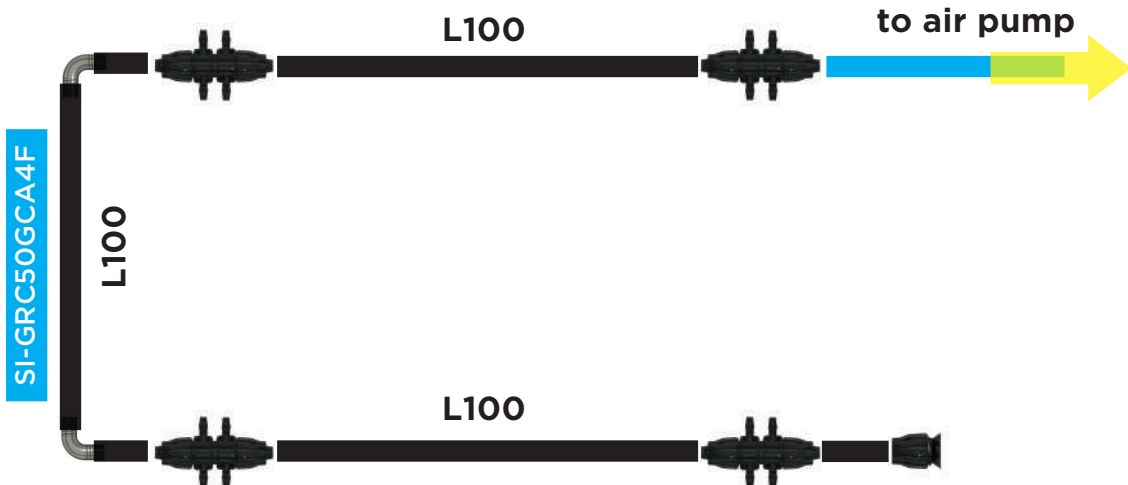



# DISTRIBUTION AIR LINE KIT

## RDWC 18 - 3 ROWS

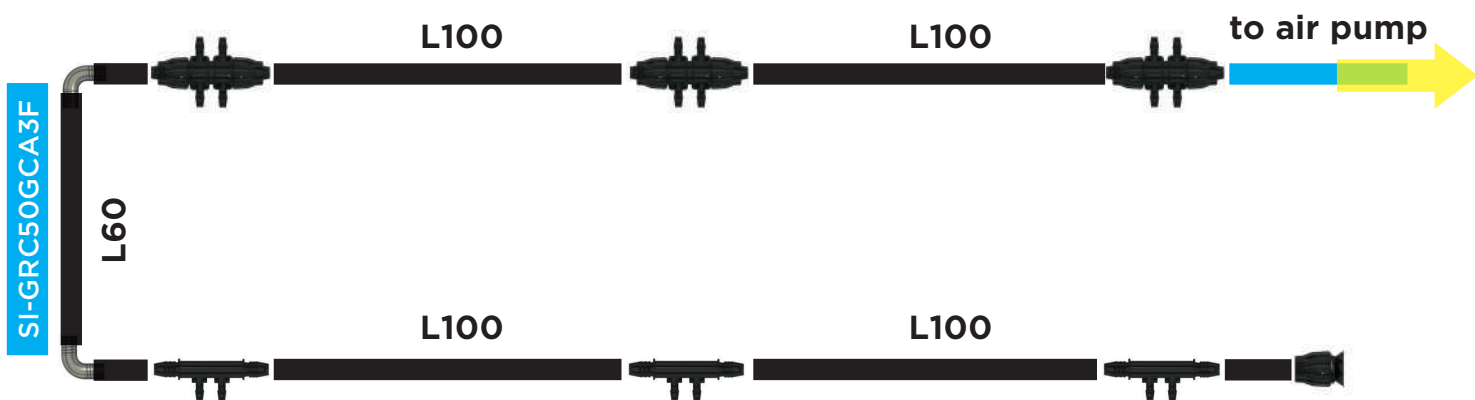
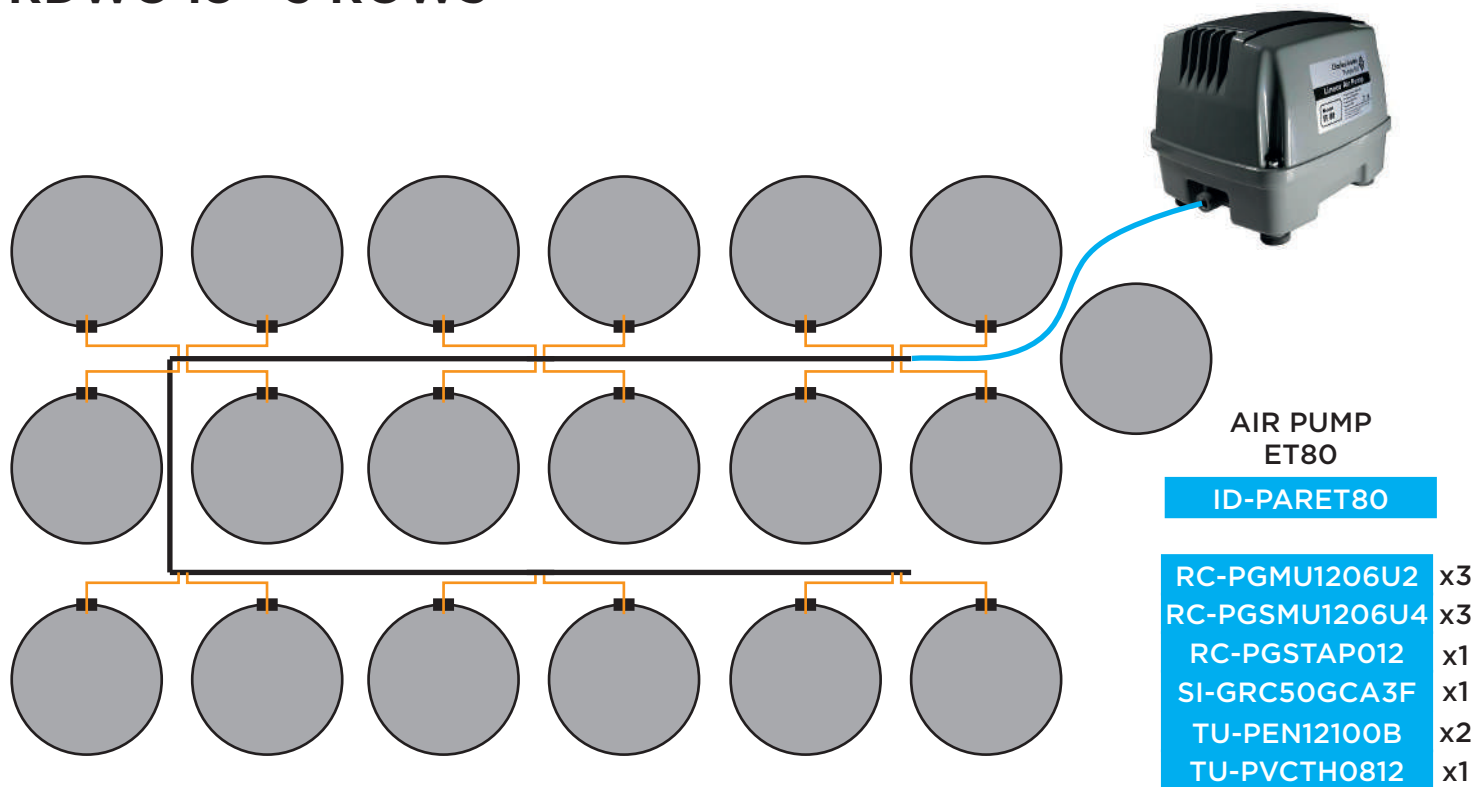

# RDWC 24- 4 ROWS

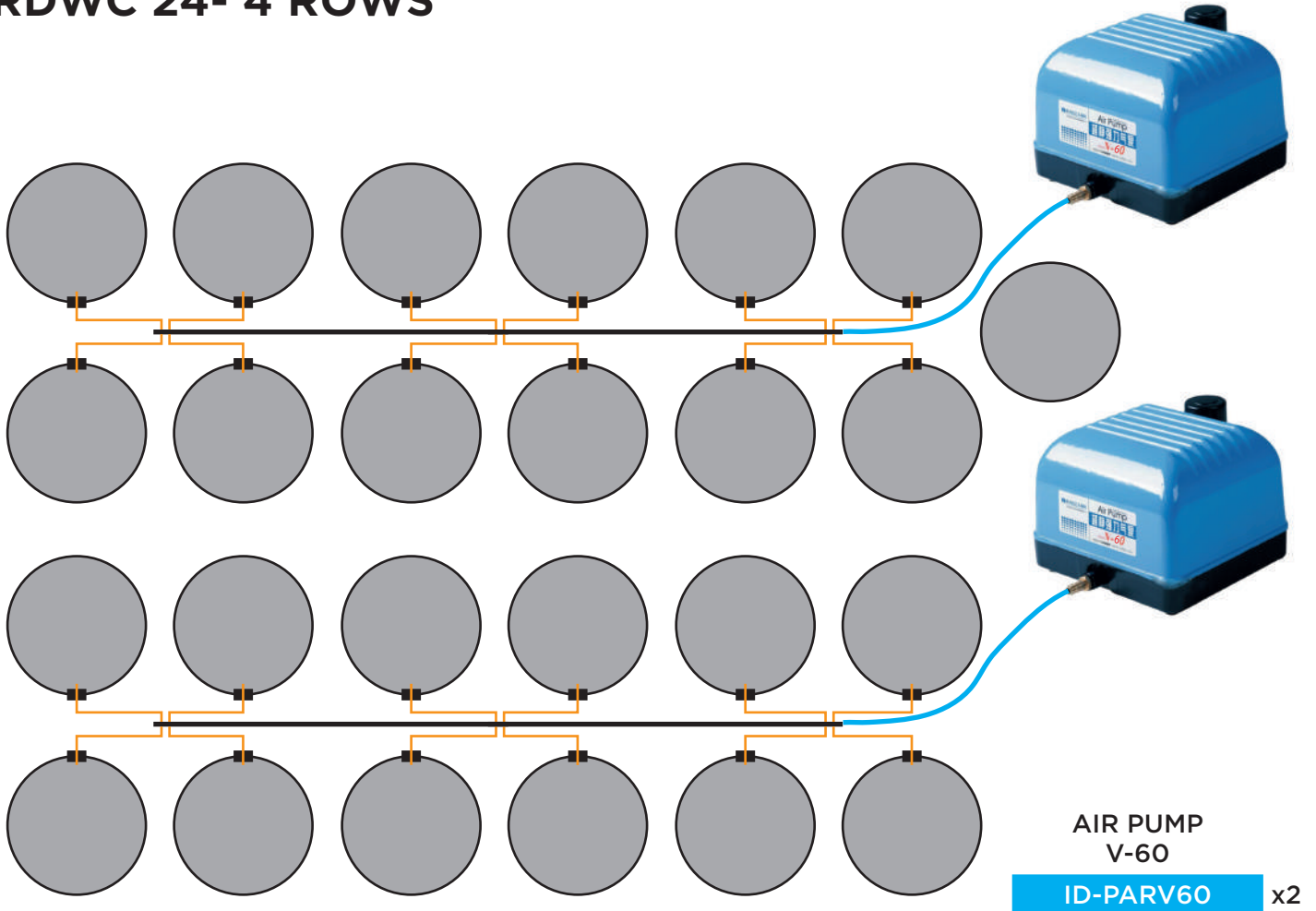

- AIR PUMP V-60
- ID-PARV60 x2
- RC-PGSMU1206U4 x6
- RC-PGSTAP012 x2
- TU-PEN12100B x4
- TU-PVCTH0812 x1



# DISTRIBUTION AIR LINE KIT

**g) Air Stones.** Connect the air stone as shown in the picture below

**AIR STONES:** the air stone are used to release the air from the pump in order to oxygenate the water and then increase the oxygene of the solution inside the pots. FRAGILE HANDLE WITH CARE!

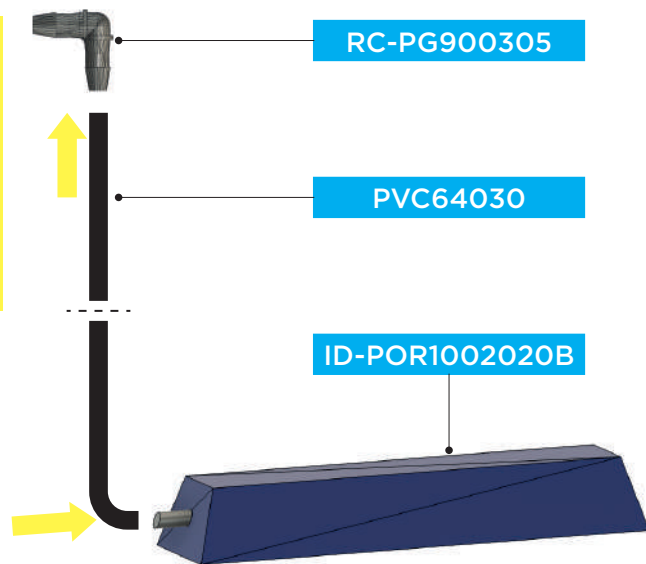
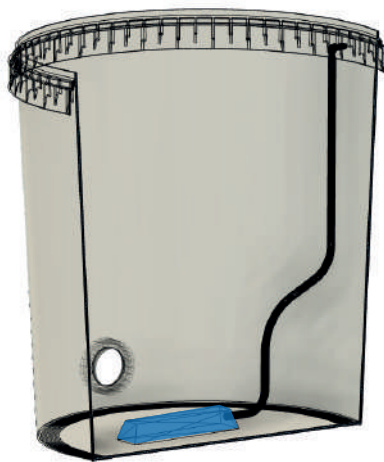

**h)** Place the air stones in every growing pots

**i) END LINE.** connect the air manifold to the air stone

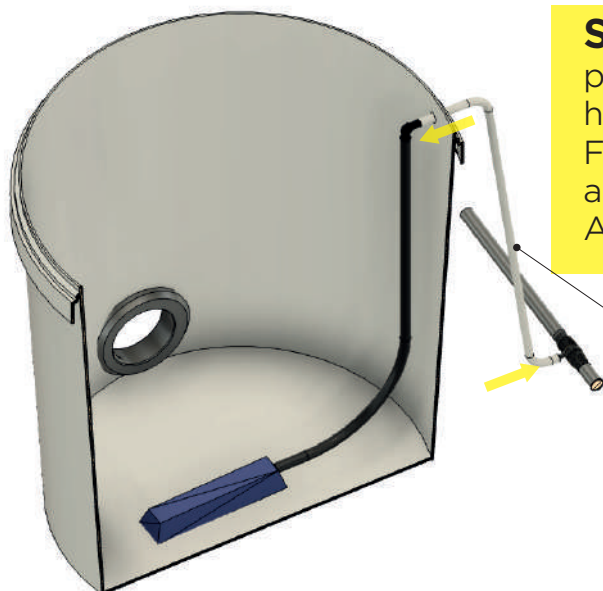

**SILICON AIR HOSE.** cut a piece of 50/60cm of silicon air hose and connect the AIR MANIFOLD with 3X5MM ELBOW of the air stone, passing it through the AIR GASKETS of the growing pot

TU-SILO604100

## I) Complete installed system example.

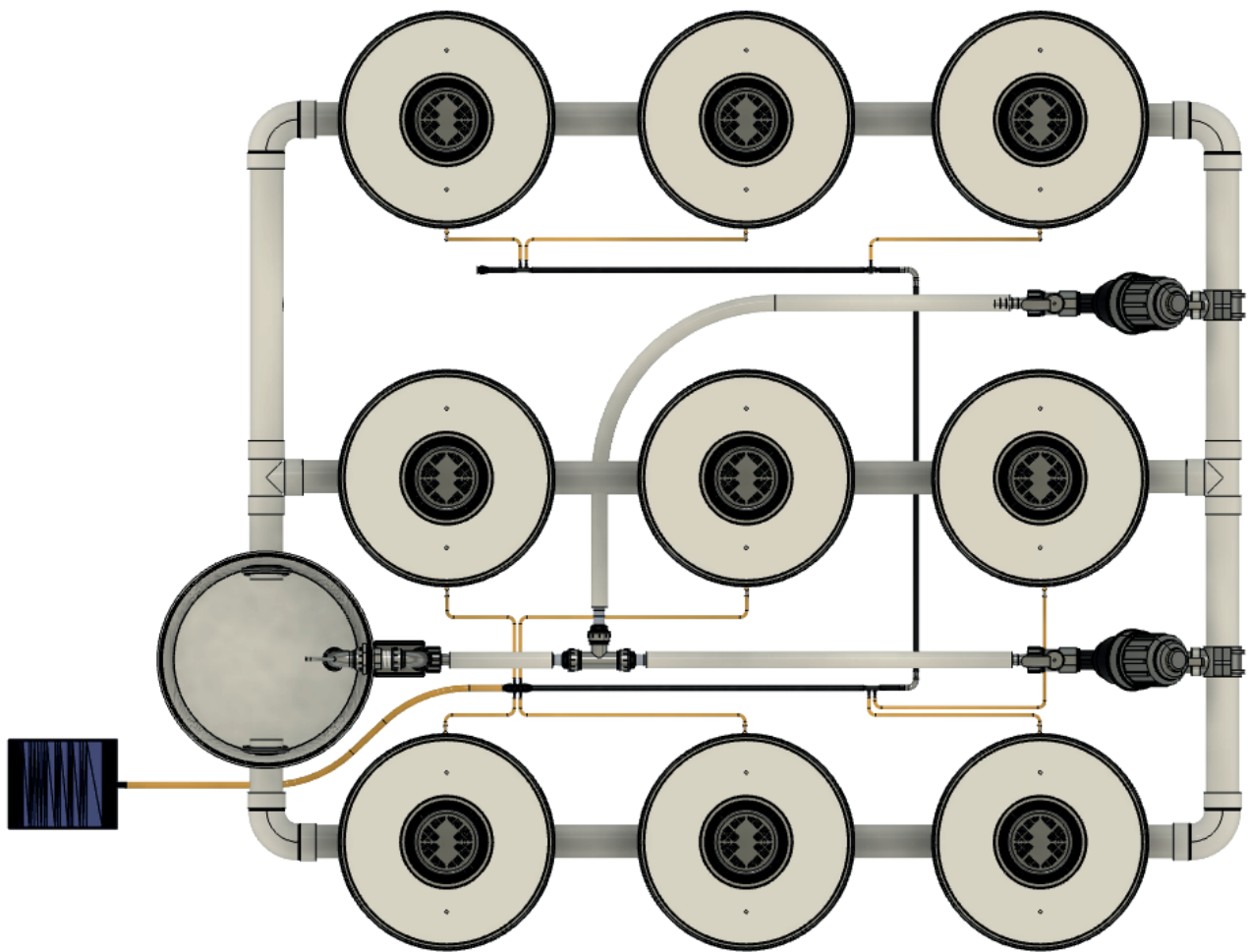

# SYSTEM TESTING

## STEP 3 SYSTEM TESTING

Now that your system has been assembled let's proceed with the testing of the system before starting with to load the solution and start growing. Follow the step below:

**1) FITTING.** Make sure you have tightened all the threaded fittings across the RETURN HOSE 20MM from the IN LINE FILTER KIT to the WATER PUMP.

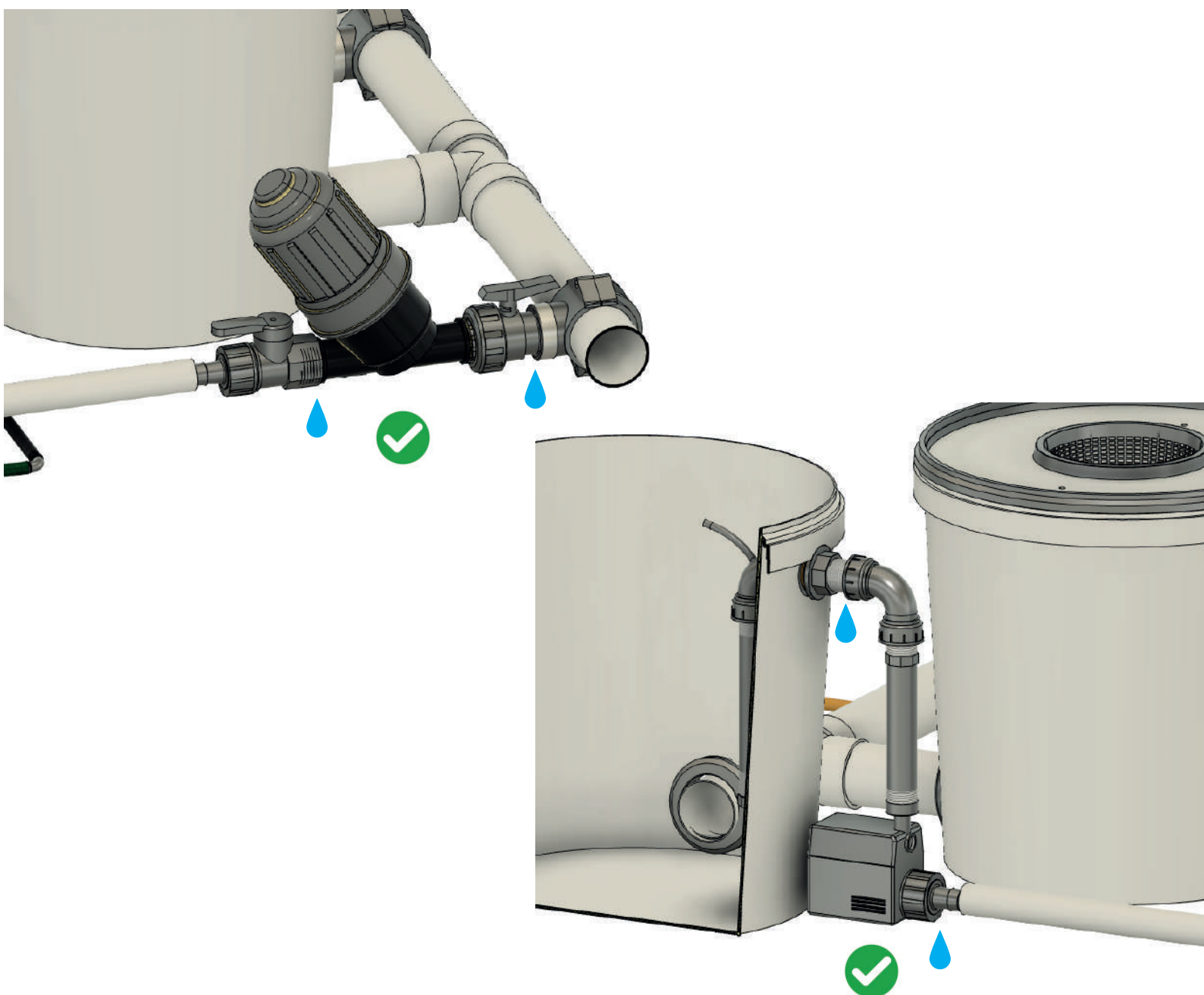

**2) GASKETS.** Fill the system with water until the connecting pipe will be covered 1 cm. Switch on the water pump and wait for about 15 min, let the water circulate throughout the system and look for any water leak. If you recognize a leak go to the TROUBLESHOOTING CHART and find the right way for fixing it.

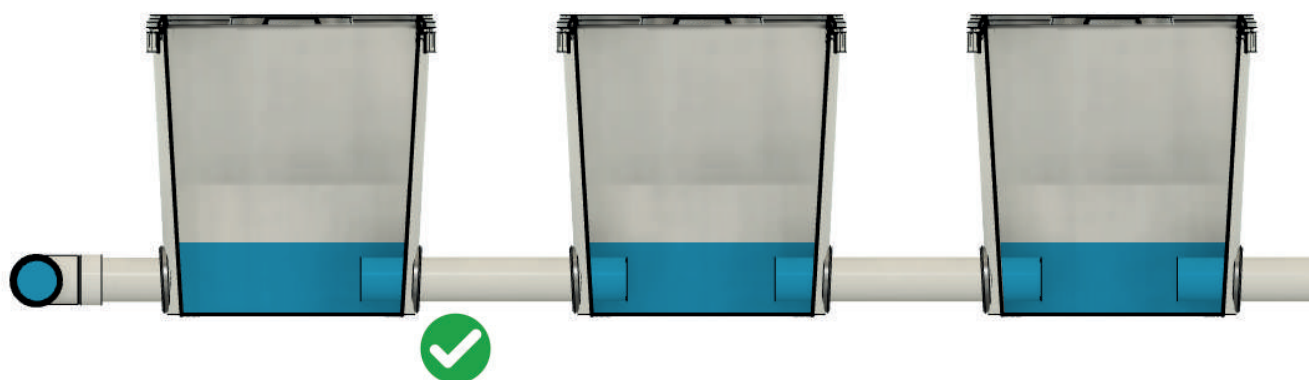

**3) SYSTEM VALVE .** Before switching on the water pump make sure that the two valves ( before and after the in line filter) are open. Switch on the water pump and let the water run, it may happen that some air bubble inside the RETURN HOSE could hinder the water flow. if it happens just turn the pump off and on again until the water starts to come out in the control pot.

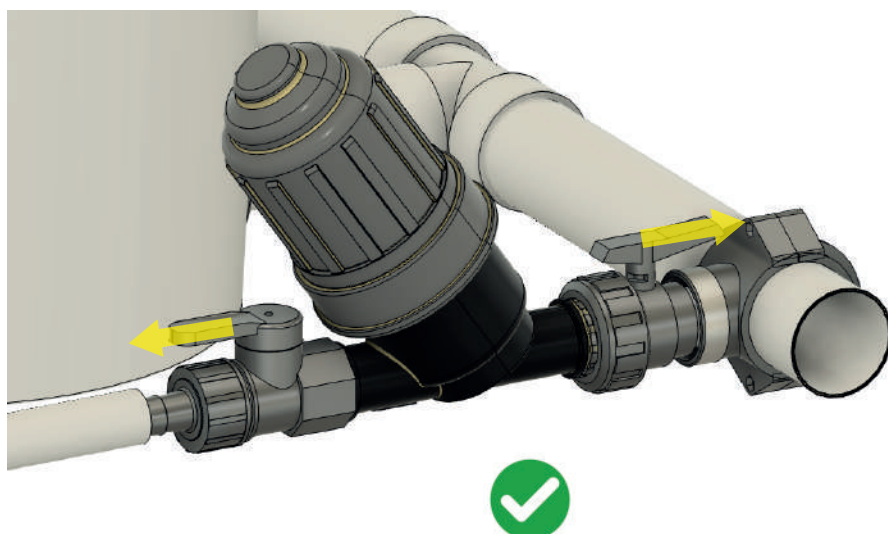



# SYSTEM TESTING

**4) AIR DISTRIBUTION.** connect the air pump to the power supply and check that all the air stone works fine.



**5) LOADING THE SYSTEM.** Fill the system with water up to the level of the bottom of the net pots.

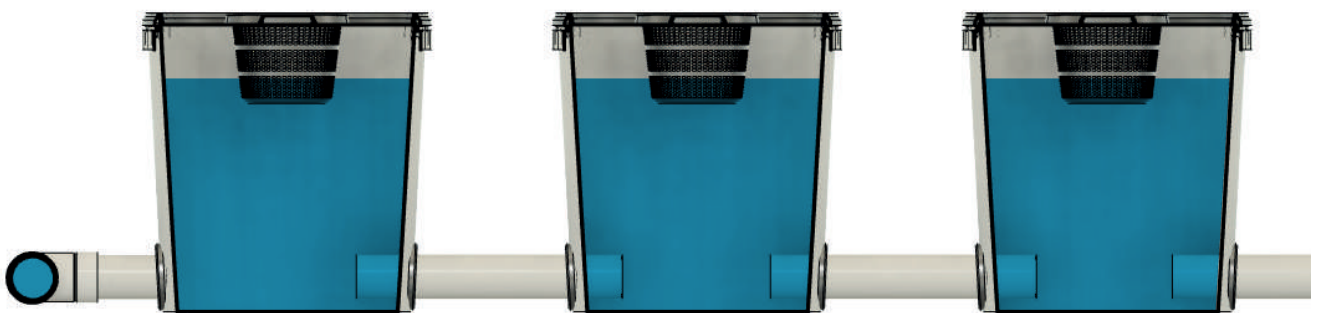

**6) TEST.** Let the system running for a while checking that everything is working properly before starting to grow





**7) NUTRIENT SOLUTION.** now you are ready to make your nutrient solution. Use the control pot for ceck your EC and pH level . Calibrate the solution as needed by placing fertilizers or pH regulators in the control pot. Let the solution circulate inside the system and let the EC and pH values stabilize, then double check and correct if needed



*NB: choose your cultivation range well, on our website you can find a wide choice of fertilizers, additives and tools, as well as tutorials for correct use. [www.growrillahydroponics.com](http://www.growrillahydroponics.com)*

# CUSTOMIZE SYSTEM

## STEP 5 MODIFY AND CUSTOMIZE YOUR SYSTEM

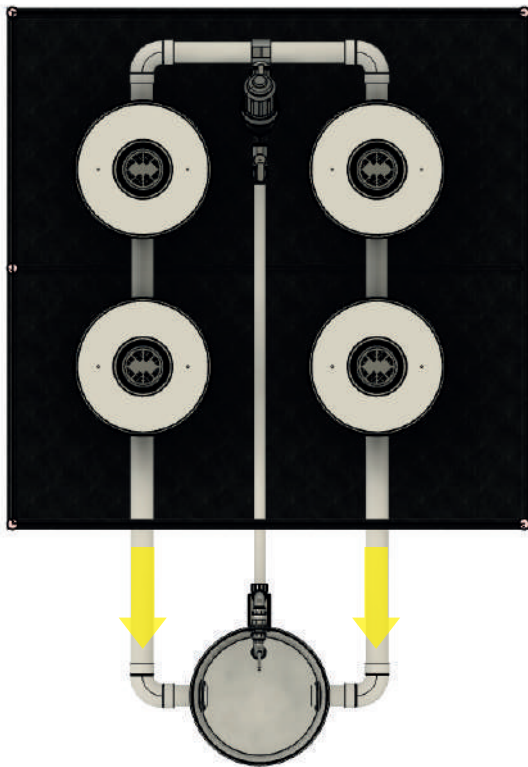
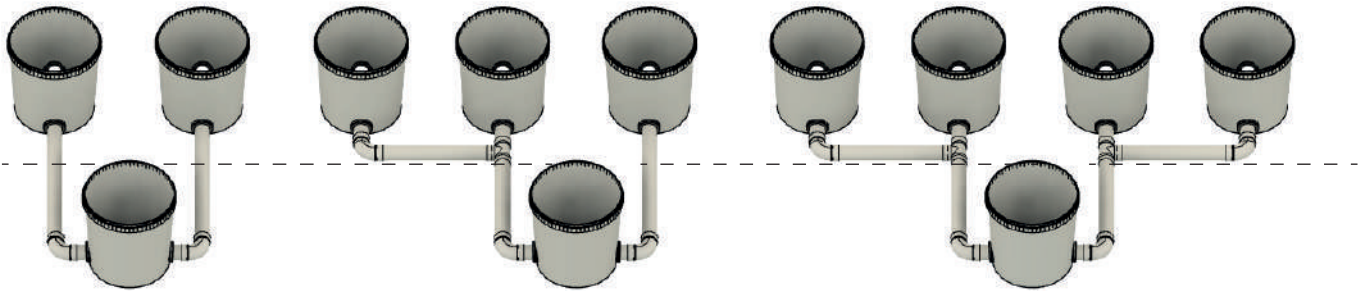

The new GROWRILLA RDWC PRO systems can be easily modified and customized according to the grower's needs. Everything is made particularly simple thanks to the use of push fit fittings that allow them to be disassembled and reassembled as needed.



# EXTENDED PIPES

**a) EXTENDED PIPES.** For example, you can extend the distance of the control pot from the growing pots to place it outside the grow tent.

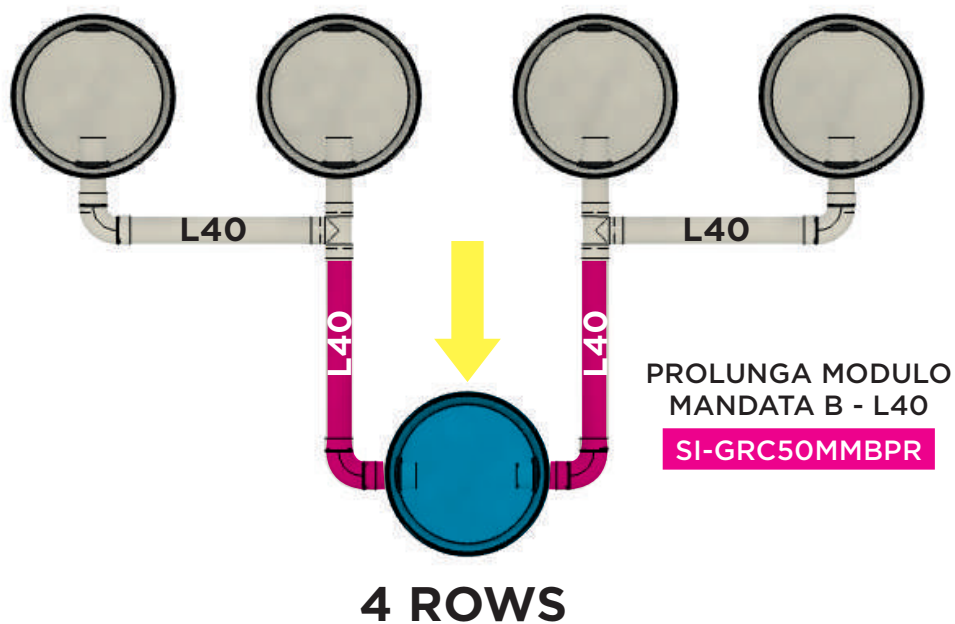
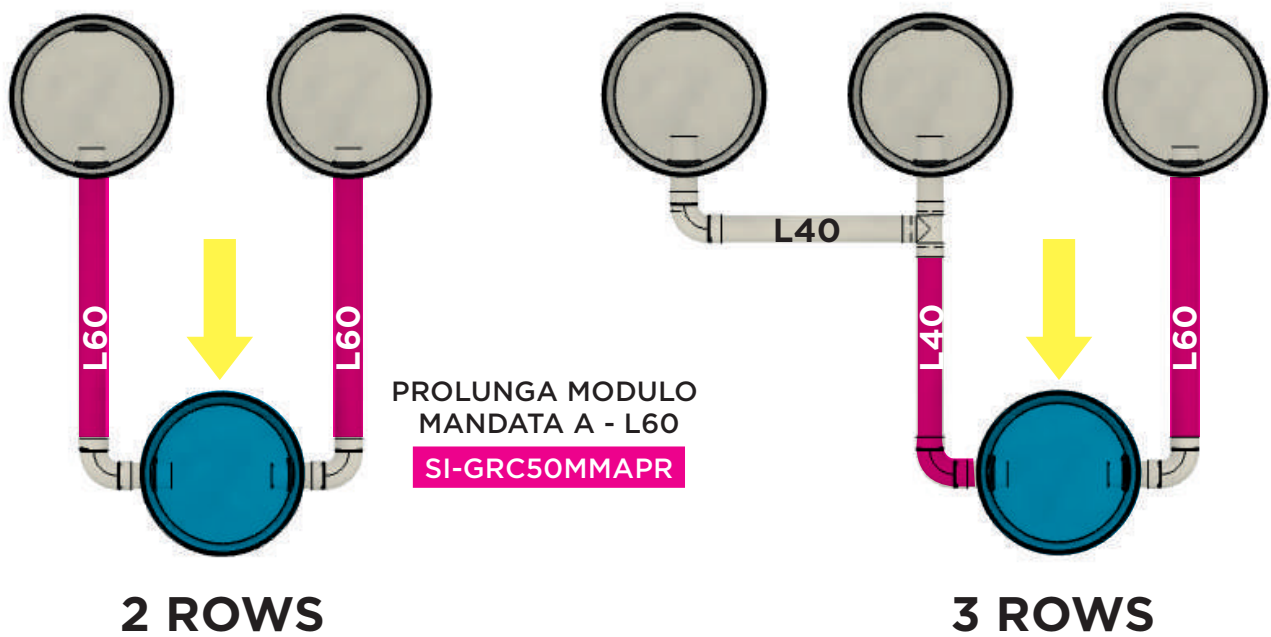

# INTEGRATION CHILLER

**b) Run the chiller with RECIRCULATION PUMP.** you can connect a chiller or a refrigeration unit to the system in order to keep the water temperature under control. You can doing that in two different way.

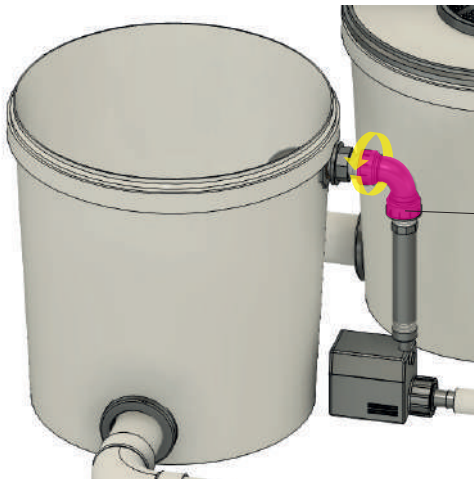

Switch off the recirculating water pump.

RC-FIL90CCFFGM

**A.** Unscrew the elbow fitting from the bulkhead as shown in the picture

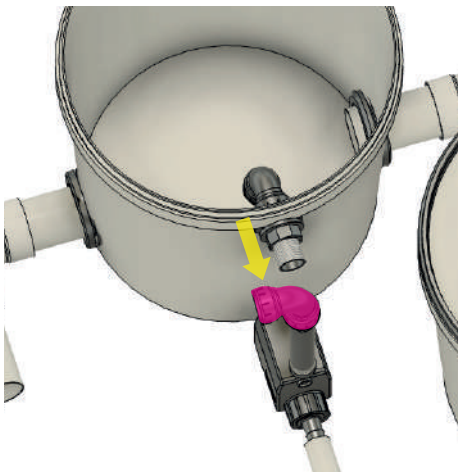

**B.** Turn it 90°

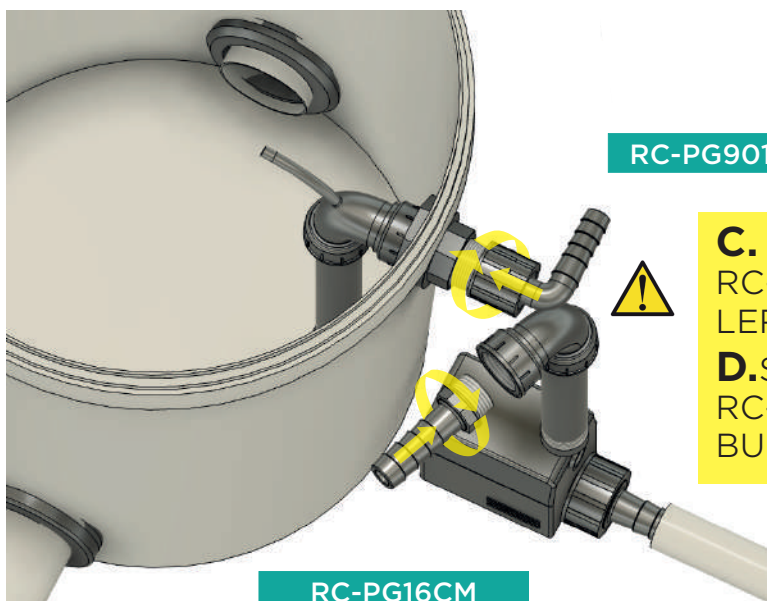

RC-PG9016CGM

**C.** Screw the barbed fitting RC-PG16CM to the elbow (CHILLER IN)

**D.** Screw the barbed fitting RC-PG9016CGM to the BULKHEAD  $\frac{3}{4}$ " (CHILLER OUT)

# INTEGRAZIONE CHILLER

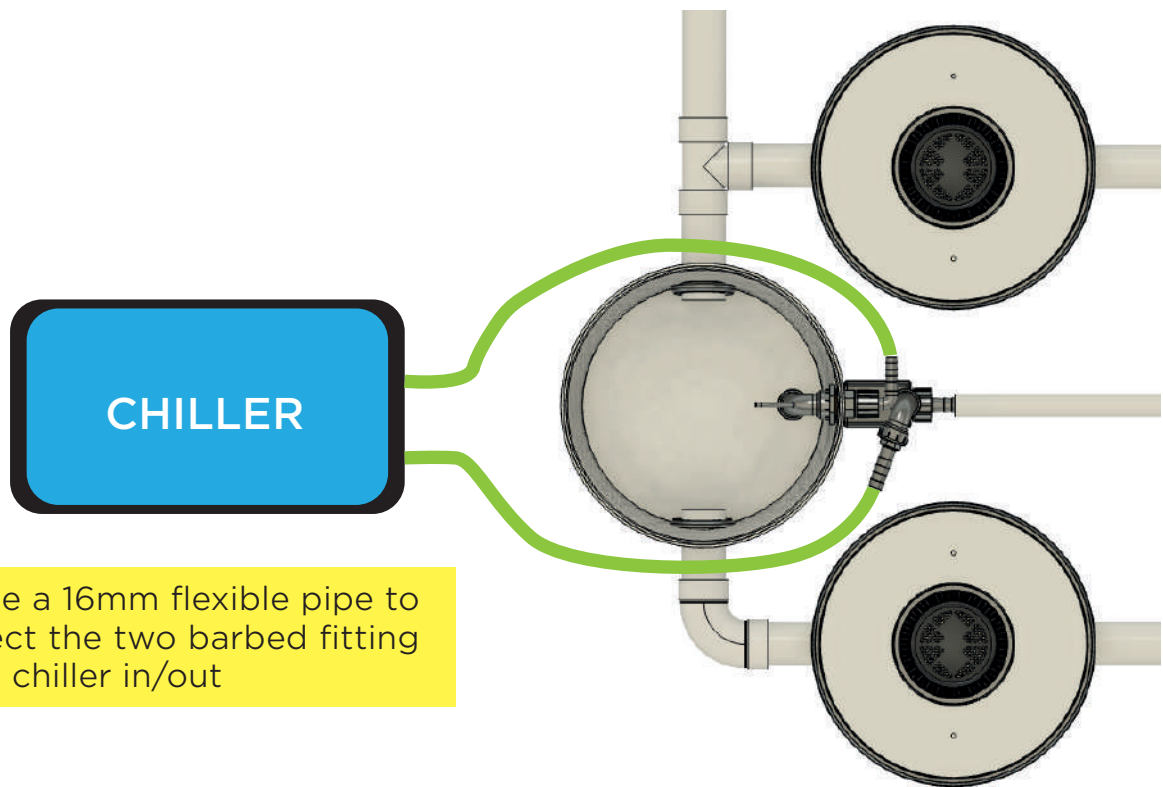

**F.** Use a 16mm flexible pipe to connect the two barbed fitting to the chiller in/out

**b) Run the chiller with an INDEPENDENT PUMP.** The chiller can be connected by another water pump as shown in the picture below. The use of an independent pump is highly recommended to keep the flow rate of the solution in the system separated from the water flow to the chiller. In this way you can run the chiller with a flow rate calibrated to his technical specifications.

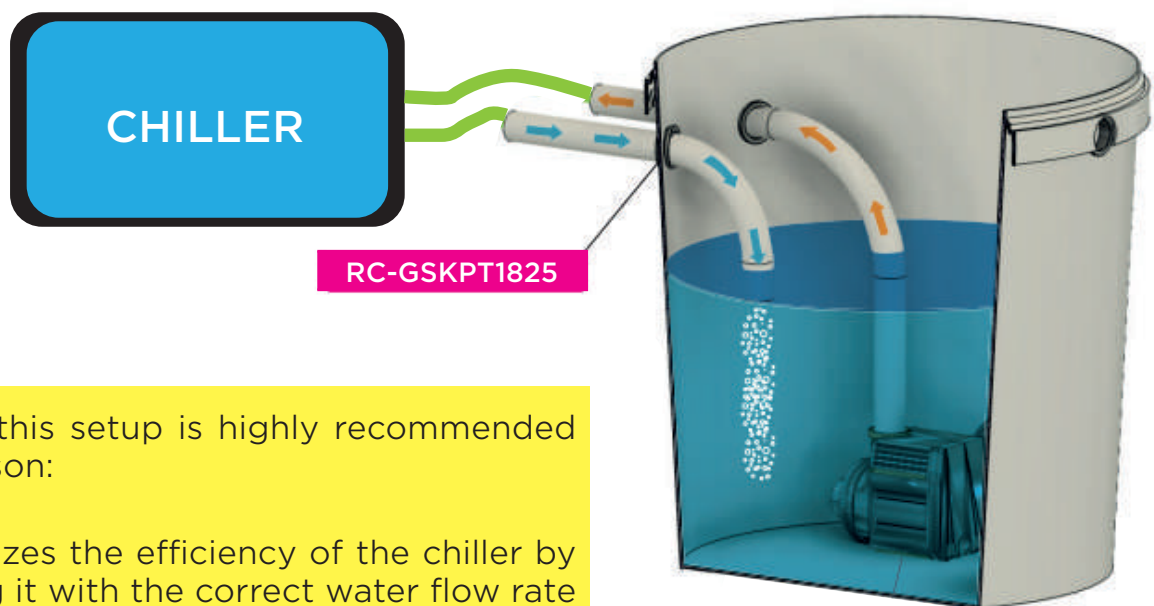

**NOTE.** this setup is highly recommended for 2 reason:

- 1)** optimizes the efficiency of the chiller by providing it with the correct water flow rate
- 2)** it does not reduce the flow rate of the circulation pump of the system



# FLOATING VALVE

**d) FLOATING VALVE.** Floating valves allow you to connect the system with a separated water storage tank in order to always keep the right water level. When the water level in the system drops, the valve opens allowing new water to enter until the set level is reached.

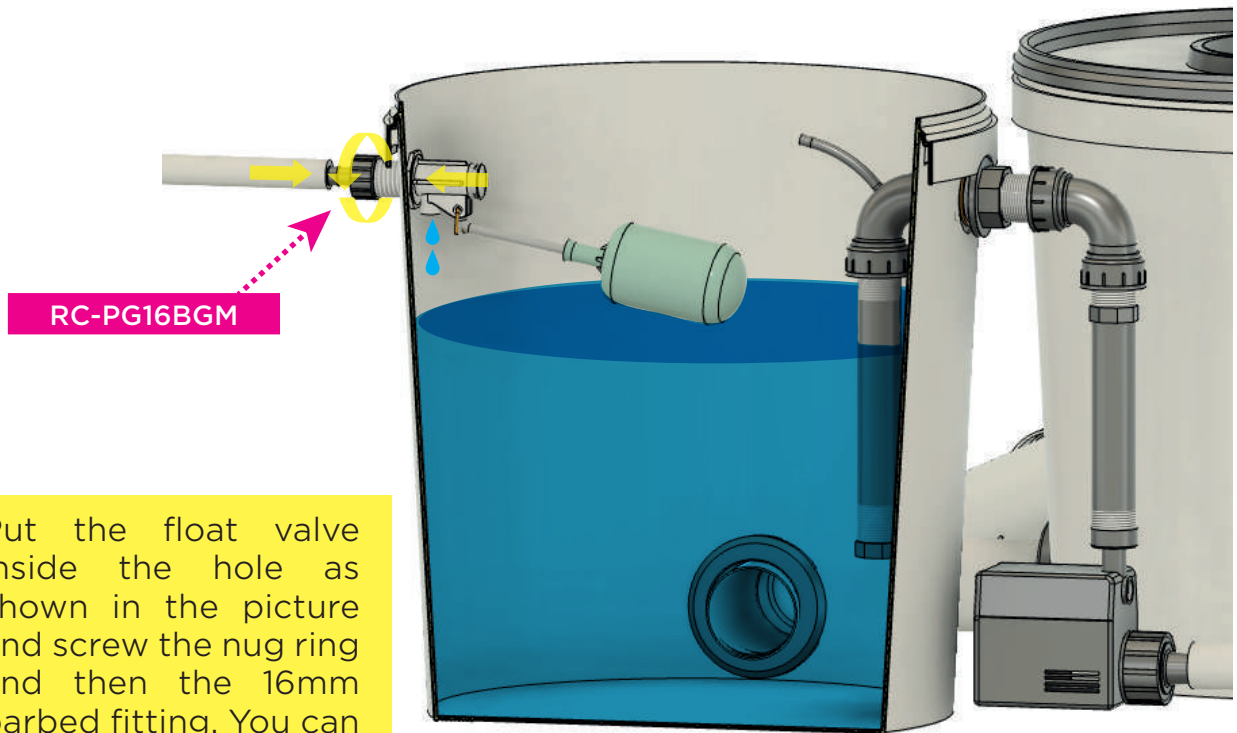

Put the float valve inside the hole as shown in the picture and screw the nut ring and then the 16mm barbed fitting. You can use any 16mm flexible hose with it.

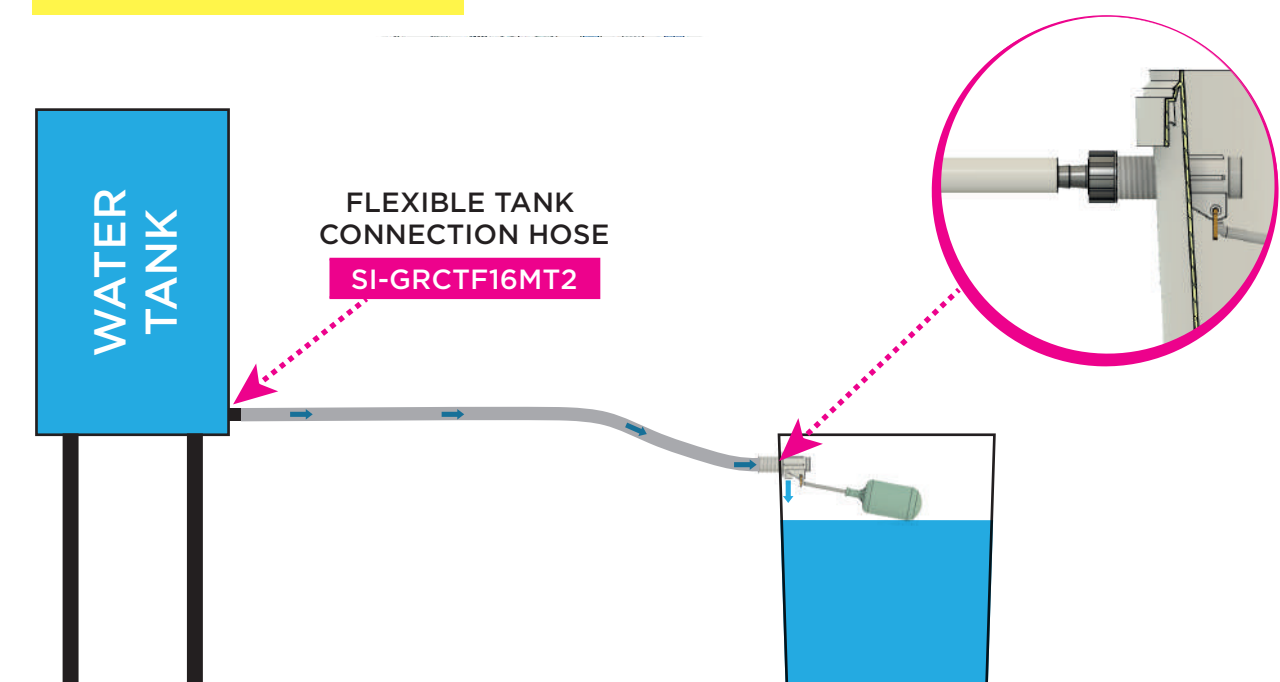

# SYSTEM DOWNLOAD CLEANING

For system unloading operations, refer to the methods listed below.  
You can download the system in two different way:

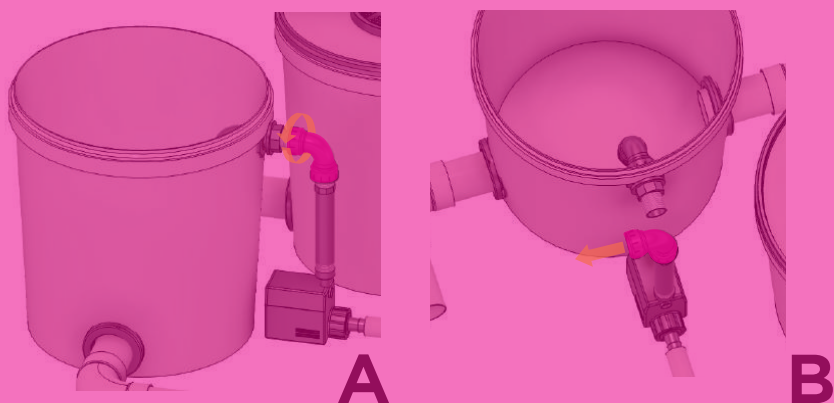

**A**

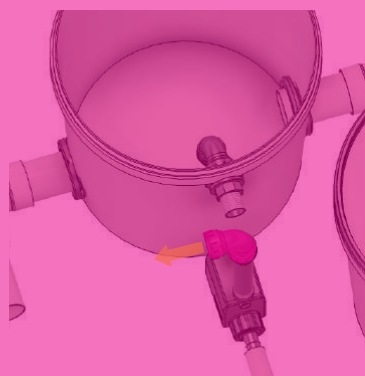

**B**

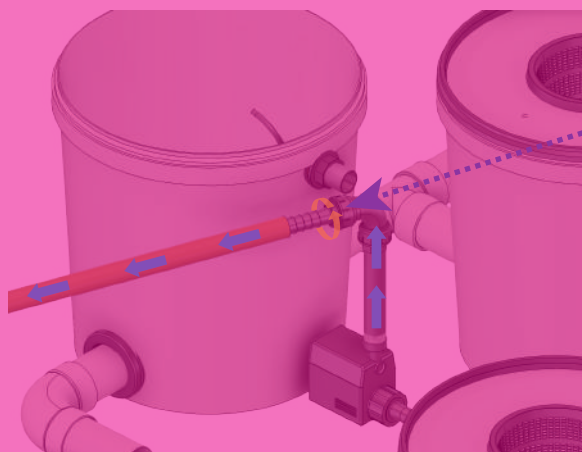

**C**

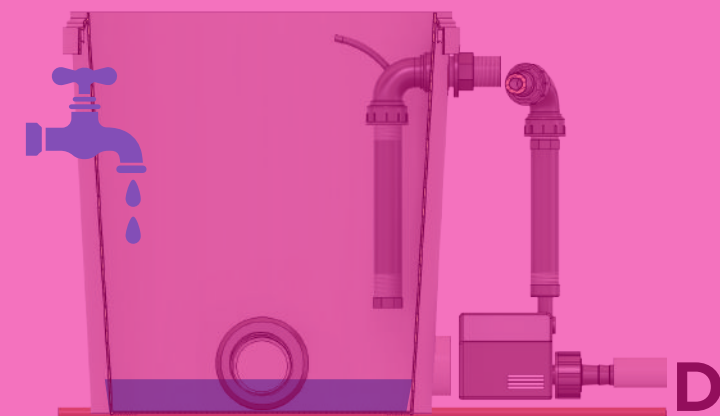

**D**



**E**

**A.** Svita la ghiera mobile del gomito a 90°.

**B.** Posiziona il gomito come in figura.

**C.** Posiziona il portagomma maschio sul gomito e collega un tubo flessibile su di esso, indirizzalo successivamente verso uno scarico.

**D.** Per eliminare il fondo della soluzione.

- aggiungi a questo punto acqua pura con la pompa in funzione ed effettua un risciacquo della soluzione per eliminare i residui.

**E.** Rimuovi eventuali residui all'interno dei vasi prima di ultimare il risciacquo.

**RIPRISTINARE** nuovamente il sistema scollegando il chiller, e portare a livello con la nuova soluzione e rizionare la pompa.



# RDWC HOW DOES IT WORK?

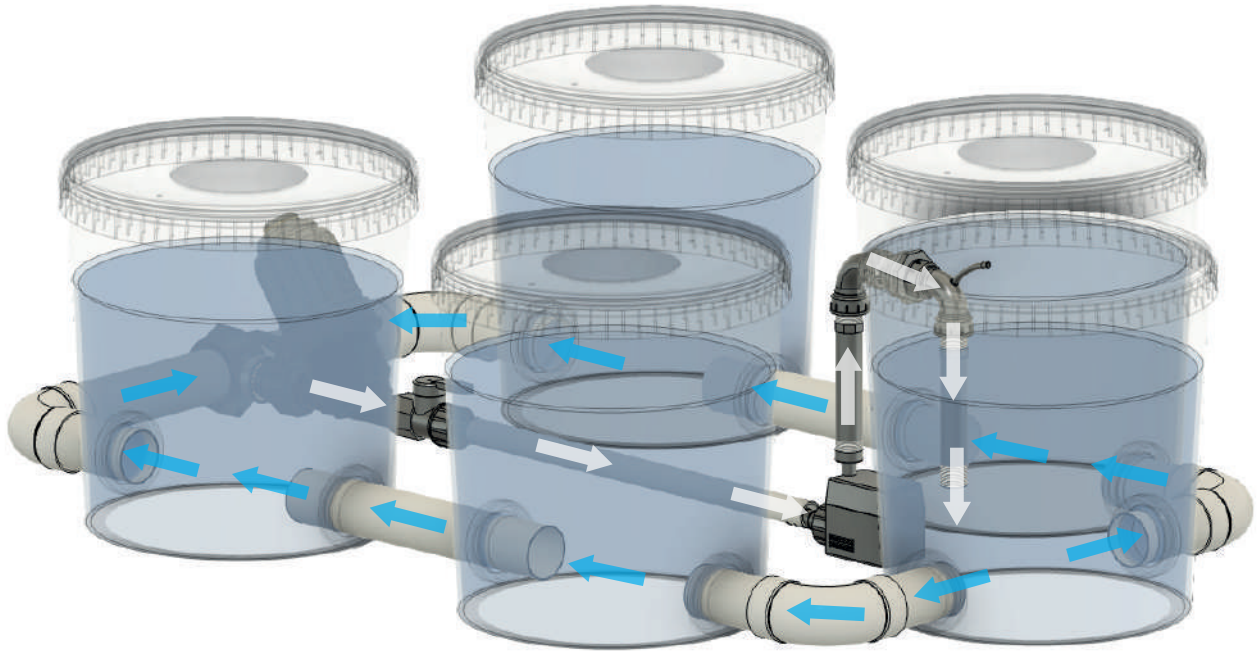

**DWC**, aka Deep Water Culture is one of the best performing methods for growing hydroponic plants.

The plant grows with the roots immersed in a nutrient solution constantly oxygenated by an air pump. The high value of dissolved oxygen available directly to the plant's roots increases growth processes, accelerating development and increasing the weight of the crop.

**RDWC** means Recirculating Deep Water Culture, the solution is constantly mixed within the system by a recirculation pump, standardizing the values of EC and pH.

By the controller pot you can check and regulate your nutrient solution circulating throughout the system

This way more growing pots can be connected together making your system fully expandable and able to cover any growing area, from small grow boxes to large cultivation rooms.



## COLTIVARE IN UN SISTEMA DWC

La chiave della coltivazione con i sistemi deep water culture sta nell'ossigenazione della soluzione nutritiva e nello specifico nel contenuto di ossigeno disciolto all'interno della **soluzione** nutritiva.

In ogni vaso di coltivazione è presente una **pietra porosa** collegata ad un aeratore mediante una **linea di distribuzione dell'aria**.

Attraverso la pietra porosa l'aria sprigionata all'interno del vaso muove la soluzione dal basso verso l'alto inducendo uno scambio gassoso tra aria e acqua e caricando quest'ultima di ossigeno.

L'alto valore di ossigeno disciolto disponibile direttamente alle radici della pianta aumenta i processi di crescita, accelerando lo sviluppo ed aumentando il peso del raccolto.



Per maggiori informazioni sulla coltivazione DWC ti consigliamo di visionare la nostra guida.

[growrillahydroponics.com/coltivazione-dwc/](http://growrillahydroponics.com/coltivazione-dwc/)



**+39 329 3237168**



**Strada Comunale da Bertolla  
all'Abbadia di Stura, 140  
10156 Torino - ITALY**



**[www.growrillahydroponics.com](http://www.growrillahydroponics.com)  
[info@growrillahydroponics.com](mailto:info@growrillahydroponics.com)**